



Tarifa 2024

www.risiberia.es

ÍNDICE



 Agricultura 4.0	2 - 7	 Programadores	67 - 71
 Riego y conducción	8 - 30	 Electroválvulas	72 - 74
 RIS Valves	31 - 52	 Difusores y aspersores	75 - 80
 Contadores	53 - 53	 Complementos jardinería	81 - 84
 Fertilización	54 - 56	 Nebulización	85 - 86
 Filtración	57 - 66	 Césped artificial	87 - 87



SPHERAG

DISPOSITIVOS

Atlas es nuestra gama de dispositivos IoT capaces de recoger y enviar datos en tiempo real, monitorizar contadores y automatizar válvulas e hidrantes.



- ▲ **Plug & Play:** instalación rápida y sencilla.
- ▲ **Completamente autónomos:** alimentados por energía solar.
- ▲ **No requieren cableado.**
- ▲ **No precisan conectividad dedicada** (gateways / antenas de comunicación).
- ▲ **Funcionan en lugares remotos:** tecnología CATM-1, NBIoT o GPRS.
- ▲ **Mantenimiento sencillo:** solo hay que mantener limpia la placa solar.
- ▲ **Edge Intelligence:** incluyen algoritmos de IA integrados que ayudan a prever incidencias.
- ▲ **Espacio para hasta 8 contadores y hasta 8 válvulas.**

SENSORES

Una amplia gama de sensores conectados a los dispositivos ofrecen información precisa y en tiempo real.



Sensor de suelo



Sensor de presión



Sensor de nivel

GESTIÓN INTELIGENTE DEL RIEGO

PLATAFORMA PARA COMUNIDADES DE REGANTES

BENEFICIOS

Desde SPHERAG simplificamos la adopción de tecnología aplicada al riego agrícola y a la gestión inteligente del agua para todo tipo de usuarios profesionales, redes de distribución y comunidades de regantes.



Plataforma específica para comunidades de regantes ✓

Roles de usuario ✓

Sistema de alertas ✓

Acceso remoto y multidispositivo ✓

- ✓ Ahorro de tiempo y costes
- ✓ Manejo sencillo
- ✓ Instalación modular y escalable
- ✓ Servicio técnico a disposición del usuario



SOFTWARE

El software de SPHERAG permite a los administradores de una comunidad de regantes garantizar un uso eficiente del agua, controlar su distribución y tiempo, y mucho más:

-  **Monitorización de contadores**
-  **Creación y asignación de dotaciones**
-  **Organización y agrupación de contadores**
-  **Asignación de precios, seguimiento y exportación de informes**
-  **Programación de válvulas por tiempo o caudal**



ALERTAS ⚠

La solución de SPHERAG ofrece un servicio de alertas que ayudan a reducir el uso excesivo del agua y garantizan la seguridad de la instalación. Las alertas se reciben en tiempo real por SMS o correo electrónico, y también pueden visualizarse en la plataforma.



Consulta precio y condiciones en [página 67](#)



Packs Estaciones básicas

Pack nMETOS 80

Código	Artículo	€/Ud.
619800	nMETOS 80	837,86
610038	Poste inox 1,5 m para nMETOS y mMETOS	67,90
784210	Tarjeta SIM NBloT(4 años)	181,07
TOTAL		1.086,83



ENERGÍA 100% SOLAR

Monitorización autónoma con comunicación NBloT. Mide temperatura de aire, humedad relativa, punto de rocío, DPV y Delta T (momento óptimo para pulverizar).

Pack nMETOS 80 SM

Código	Artículo	€/Ud.
619802	nMETOS 80 SM	1.292,18
610038	Poste inox 1,5 m para nMETOS y mMETOS	67,90
784210	Tarjeta SIM NBloT(4 años)	181,07
TOTAL		1.541,15



ENERGÍA 100% SOLAR

Monitorización autónoma con comunicación NBloT. Mide temperatura de aire, humedad relativa, punto de rocío, DPV, Delta T (momento óptimo para pulverizar), temperatura, humedad de suelo y tensiómetro (momento óptimo para riego).

Pack nMETOS 180

Código	Artículo	€/Ud.
619600	nMETOS 180	1.218,11
610038	Poste inox 1,5 m para nMETOS y mMETOS	67,90
784212	Tarjeta SIM 1 año	181,07
TOTAL		1.467,08



ENERGÍA 100% SOLAR

Monitorización autónoma con comunicación NBloT. Mide precipitaciones, temperatura de aire, humedad relativa, punto de rocío, DPV, Delta T (momento óptimo para pulverizar) y humectación de hoja (calc).

Pack nMETOS 180 SM

Código	Artículo	€/Ud.
619602	nMETOS 180 SM	1.670,78
610038	Poste inox 1,5 m para nMETOS y mMETOS	67,90
784210	Tarjeta SIM NBloT(4 años)	181,07
TOTAL		1.919,75



ENERGÍA 100% SOLAR

Monitorización autónoma con comunicación NBloT. Mide precipitaciones, temperatura de aire, humedad relativa, punto de rocío, DPV, Delta T (momento óptimo para pulverizar), temperatura, humedad de suelo y tensiómetro y humectación de hoja (calc).

Pack nMETOS 200 Enfermedades

Código	Artículo	€/Ud.
603200	nMETOS 200	1.670,78
606220	Modelo enfermedades 1 cultivo/año	147,87
606225	Cuota predicción climática + planificación de trabajo	315,36
610040	Poste inox 1,5 m doble telescópico	271,60
784210	Tarjeta SIM NBloT(4 años)	181,07
TOTAL		2.586,69



ENERGÍA 100% SOLAR

Monitorización autónoma con comunicación NBloT. Mide precipitaciones, temperatura de aire, humedad relativa, punto de rocío, DPV, Delta T (momento óptimo para pulverizar) y humectación de hoja.

Preparada para modelo de enfermedades + predicción clima.

Pack nMETOS 100

Código	Artículo	€/Ud.
603100	nMETOS 100	837,86
610038	Poste inox 1,5 m para nMETOS y mMETOS	67,90
784210	Tarjeta SIM NBloT(4 años)	181,07
TOTAL		1.086,83



ENERGÍA 100% SOLAR

Monitorización autónoma con comunicación NBloT. Mide precipitaciones.

Pack nMETOS FROST

Código	Artículo	€/Ud.
603007	nMETOS FROST	1.158,85
610038	Poste inox 1,5 m para nMETOS y mMETOS	67,90
784210	Tarjeta SIM NBloT(4 años)	181,07
TOTAL		1.407,82



Monitorización autónoma con comunicación NBloT. Temperatura de búlbo húmedo y seco para protección contra heladas.

Packs Estaciones avanzadas

Pack mMETOS Suelo

Código	Artículo	€/Ud.
581072	mMETOS NBloT Base	1.167,08
398080	Sonda Enviopro 80 cm (Humedad y T°)	1.507,54
610038	Poste inox 1,5 m para nMETOS y mMETOS	67,90
784210	Tarjeta SIM NBloT(4 años)	181,07
TOTAL		2.923,59



ENERGÍA 100% SOLAR

Monitorización autónoma con comunicación NBloT. Mide humedad y temperatura de suelo a diferentes profundidades.

Pack mMETOS Riego

Código	Artículo	€/Ud.
581072	mMETOS NBloT Base	1.167,08
811015	Tensiómetro Digital Irrrometer 15cm	467,00
811045	Tensiómetro Digital Irrrometer 45cm	488,34
329000	Contador Js smart con emisor de pulsos	128,40
610038	Poste inox 1,5 m para nMETOS y mMETOS	67,90
784210	Tarjeta SIM NBloT(4 años)	181,07
TOTAL		2.499,78



ENERGÍA 100% SOLAR

Monitorización autónoma con comunicación NBloT. Mide momento óptimo para riego y volumen de agua.

Riego

Ris Valves

Contadores

Fertilización

Filtración

Programadores

Electroválvulas
irritrol

Difusores y
aspersores

Complementos
jardinería

Nebulización

Césped artificial

Pack mMETOS 200 Enfermedades

Código	Artículo	€/Ud.
581075	mMETOS NBloT Enfermedades	2.678,19
606220	Modelo enfermedades 1 cultivo/año	147,87
606225	Cuota predicción climática + planificación de trabajo	315,36
784210	Tarjeta SIM NBloT(4 años)	181,07
610038	Poste inox 1,5 m para nMETOS y mMETOS	67,90
TOTAL		3.390,40

 **ENERGÍA 100% SOLAR**

Monitorización autónoma con comunicación NBloT. Mide precipitaciones, temperatura ambiente, humedad relativa, punto de rocío, DPV, Delta T (momento óptimo para pulverizar) y humectación de hoja.

Preparada para modelo de enfermedades + predicción clima.

 **ENERGÍA 100% SOLAR**

Pack mMETOS 280 Evapotranspiración

Código	Artículo	€/Ud.
581078	mMETOS NBloT Evapotranspiración	4.021,40
606225	Cuota predicción climática + planificación de trabajo	315,36
784210	Tarjeta SIM NBloT(4 años)	181,07
610040	Poste inox 1,5 m doble telescópico	271,60
TOTAL		4.789,44

Monitorización autónoma con comunicación NBloT. Mide precipitaciones, temperatura ambiente, humedad relativa, punto de rocío, DPV, Delta T (momento óptimo para pulverizar), velocidad y dirección de viento (ráfagas), radiación global y cálculo de ETO.

Preparada para modelo de enfermedades + predicción clima.

Pack Insectos

Código	Artículo	€/Ud.
870300	Unidad de control Metos	656,38
840303	Trampa electrónica para atrayente alimenticio	1.454,60
610040	Poste inox 1,5 m doble telescópico	271,60
TOTAL		2.382,58



Trampa electrónica para monitorización remota de insectos. con conteo y reconocimiento de plagas automático (identificación a nivel de orden).

Pack Cámara

Código	Artículo	€/Ud.
870300	Unidad de control Metos	656,38
198730	Cámara panorámica	1.516,46
610040	Poste inox 1,5 m doble telescópico	271,60
TOTAL		2.444,44

 **ENERGÍA 100% SOLAR**

Cámara en alta resolución para un control diario del estado de salud y fenológico del cultivo, pudiendo medir el tamaño de la fruta.

Sensores y accesorios

Código	Artículo	€/Ud.
398040	Sonda Enviropro 40 cm (Humedad y Tª)	1.211,80
398080	Sonda Enviropro 80 cm (Humedad y Tª)	1.507,54
399004	Sonda Enviropro PRO 40 cm (Humedad, Tª y C.E.)	1.507,54
399008	Sonda Enviropro PRO 80 cm (Humedad, Tª y C.E.)	2.100,96

750030	Sonda Sentek 30 cm (Humedad y Tª)	1.332,78
750035	Sonda Sentek 30 cm (Humedad, Tª y salinidad)	1.471,06
750060	Sonda Sentek 60 cm (Humedad y Tª)	1.880,11
750065	Sonda Sentek 60 cm (Humedad, Tª y salinidad)	2.068,31
750090	Sonda Sentek 90 cm (Humedad y Tª)	2.275,72
750095	Sonda Sentek 90 cm (Humedad, Tª y salinidad)	2.702,06

582405	Sensor ES-2 (C.E. y Tª de solución)	908,78
--------	-------------------------------------	--------

582154	Sensor de Temperatura y Humedad de Suelo	307,82
--------	--	--------

750310	Sensor Tª Aire y Humedad relativa	559,12
--------	-----------------------------------	--------

582548	Sensor humedad foliar con 5 m de cable	665,00
--------	--	--------

659002	Pluviómetro 0,2 mm	503,98
--------	--------------------	--------

582445	Tensiómetro Watermark	135,80
--------	-----------------------	--------

811015	Tensiómetro Digital Irrrometer 15cm	467,00
--------	-------------------------------------	--------

811045	Tensiómetro Digital Irrrometer 45cm	488,34
--------	-------------------------------------	--------

610038	Poste inox 1,5 m para nMETOS y mMETOS	67,90
--------	---------------------------------------	-------

610040	Poste inox 1,5 m doble telescópico	271,60
--------	------------------------------------	--------



Riego

Ris Valves

Contadores

Fertilización

Filtración

Programadores

Electroválvulas
irritrolDifusores y
aspersoresComplementos
jardinería

Nebulización

Césped artificial

METOS® IBERIA





Cintas de riego



Aquatraxx

Código	Artículo			€/Ud.
00605x	Aquatraxx 5 Mill	20	4250	311,41
00606x	Aquatraxx 6 Mill	20	3300	262,70
00608x	Aquatraxx 8 Mill	20	2500	225,17
00610x	Aquatraxx 10 Mill	20	2050	236,35
00615x	Aquatraxx 15 Mill	20	1300	241,14

538182	Aquatraxx 8 Mill 20 cm Rollo 125 mts.	6	125	18,81
538282	Aquatraxx 8 Mill 20 cm Rollo 250 mts.	5	250	29,68
538183	Aquatraxx 8 Mill 30 cm Rollo 125 mts.	6	125	18,81
538283	Aquatraxx 8 Mill 30 cm Rollo 250 mts.	5	250	29,68

Consulta condiciones para Aquatraxx FC (FlowControl)

Aquatraxx 22 mm

Código	Artículo			€/Ud.
0207xx	Aquatraxx 22/7 Mill	20	2150	243,54
0208xx	Aquatraxx 22/8 Mill	20	1900	236,35
0210xx	Aquatraxx 22/10 Mill	20	1400	229,16
0215xx	Aquatraxx 22/15 Mill	20	1100	264,30



Neptune N

Código	Artículo			€/Ud.
541361	Cinta NeptuneN 6/15	20	3300	222,38
541362	Cinta NeptuneN 6/20	20	3400	215,73
541363	Cinta NeptuneN 6/30	20	3500	208,12
541381	Cinta NeptuneN 8/15	20	2600	185,87
541382	Cinta NeptuneN 8/20	20	2700	184,13
541383	Cinta NeptuneN 8/30	20	2900	185,87



Neptune N Ø 22

Código	Artículo			€/Ud.
541682	Cinta Neptune 22 8/20	16	2000	178,89
541683	Cinta Neptune 22 8/30	16	2200	187,62
541684	Cinta Neptune 22 8/40	16	2300	191,11



Flat Flow

FLAT FLOW

Código	Artículo			€/Ud.
539202	Flat Flow LP 52 mm 2"	12	100	2,47
539203	Flat Flow LP 77 mm 3	10	100	3,22
539204	Flat Flow LP 104 mm 4"	10	100	4,28

539303	Flat Flow HD 77 mm 3	10	100	3,78
539304	Flat Flow HD 104 mm 4"	10	100	5,24
539305	Flat Flow HD 128 mm 5"	7	100	7,27
539306	Flat Flow HD 156 mm 6"	6	100	8,71
539308	Flat Flow HD 207 mm 8"	5	100	19,86

Código	Artículo			€/Ud.
539404	Flat Flow 6 Bar 105 mm 4"	9	100	7,35

539225	Flat Flow LP 77 mm conx 80 cm	12	100	5,00
539231	Flat Flow LP 77 mm conx 150 cm	12	100	4,40
539437	Flat Flow HD 77 mm conx 150 cm	6	100	4,99
539235	Flat Flow LP 104 mm conx 80 cm	9	100	6,17
539241	Flat Flow LP 104 mm conx 150 cm	6	100	5,53
539441	Flat Flow HD 104 mm conx 150 cm	9	100	6,81



FLAT FLOW PE White

Código	Artículo			€/Ud.
539703	Flat Flow PE 77 mm (3 Bar)	12	100	3,22
539704	Flat Flow PE 104 mm (3 Bar)	12	100	4,51
539705	Flat Flow PE 128 mm (2 Bar)	10	100	7,30

FLAT FLOW PE White con tomas incluidas

Código	Artículo			€/Ud.
539628	Flat Flow PE 77 toma 80 cm (2 Bar)	12	100	4,91
539631	Flat Flow PE 77 toma 150 cm (2 Bar)	12	100	4,28
539638	Flat Flow PE 104 toma 80 cm (2 Bar)	12	100	6,91
539641	Flat Flow PE 104 toma 150 cm (2 Bar)	12	100	5,54



Accesorios Flat Flow

Código	Artículo			€/Ud.
870013	Enlace Manguera plana 52 x PVC 50 encolar	50	1	4,62
870015	Enlace Manguera plana 77 x PVC 75 encolar	30	1	6,07
870018	Enlace Manguera plana 90 x PVC 90 encolar	18	1	6,34
870020	Enlace Manguera plana 104 x PVC 90 encolar	16	1	12,75
870022	Enlace Manguera plana 104 x PVC 110 encolar	10	1	14,40
870025	Enlace Manguera plana 128 x PVC 125 encolar	7	1	15,03
870027	Enlace Manguera plana 156 x PVC 150 encolar	4	1	25,08



490200	Junta para enlace y emplame 77 a 125	4125	165	0,12
--------	--------------------------------------	------	-----	------



Código	Artículo			€/Ud.
389050	Empalme manguera plana 52 mm	58	1	6,55
389075	Empalme manguera plana 77 mm	28	1	7,94
389090	Empalme manguera plana 90 mm	24	1	7,70
389103	Empalme manguera plana 104 mm	18	1	13,67
389125	Empalme manguera plana 128 mm	7	1	16,79
389150	Empalme manguera plana 156 mm	6	1	33,83



2048	Abrazadera 52	25	25	2,74
2075	Abrazadera 77	25	25	3,96
2103	Abrazadera 104	25	25	4,31
2125	Abrazadera 128	25	25	5,39
2156	Abrazadera 156	10	10	7,31



Accesorios layflat de compresión

Código	Artículo			€/Ud.
392902	Enlace rosca macho 2"x Layflat 52 mm	70	10	4,44
392903	Enlace rosca macho 3"x Layflat 77 mm	28	4	10,39
392904	Enlace rosca macho 4"x Layflat 104 mm	12	4	16,92
392945	Enlace rosca macho 4"x Layflat 128 mm	10	2	25,64
392905	Enlace rosca macho 5"x Layflat 128 mm	10	2	26,14
392946	Enlace rosca macho 4"x Layflat 156 mm	4	2	39,94
392906	Enlace rosca macho 5"x Layflat 156 mm	4	2	40,40



Código	Artículo			€/Ud.
788022	Te mixta Layflat 2x2"x2	24	4	9,10
788033	Te mixta Layflat 3x3"x3	12	1	21,01
788044	Te mixta Layflat 4x4"x4	5	1	34,77
788045	Te mixta Layflat 5x4"x5	4	1	51,51
788055	Te mixta Layflat 5x5"x5	3	1	54,07
788066	Te mixta Layflat 6x5"x6	2	1	84,77



396052	Manguito unión layflat 52 mm	42	6	6,90
396077	Manguito unión layflat 77 mm	16	2	16,89
396103	Manguito unión layflat 104 mm	8	2	28,17
396128	Manguito unión layflat 128 mm	6	1	43,91
396156	Manguito unión layflat 156 mm	2	1	67,70



780002	Tapón layflat 2"	84	12	4,35
780003	Tapón layflat 3"	32	4	10,30
780004	Tapón layflat 4"	16	4	16,31
780005	Tapón layflat 5"	12	2	25,61
780006	Tapón layflat 6"	4	2	39,05



399043	Manguito reducido layflat 4" x 3"	10	2	24,68
399054	Manguito reducido layflat 5" x 4"	6	1	39,28
399065	Manguito reducido layflat 6" x 5"	4	1	60,98



Accesorios cinta hasta 0,45 mm de pastilla

Código	Artículo			€/Ud.
820626	Toma layflat a cinta con anilla	500	50	0,542
820624	Toma layflat contratuerca con anillo	500	50	0,700
820628	Toma layflat a cinta con anilla 22 mm	450	50	0,882
820916	Toma Pe a cinta hasta 0,45 mm, con anilla.	1200	100	0,155
820952	Toma Pe a cinta 22 con anilla	700	50	0,368
820926	Toma PVC con junta a cinta hasta 0,45 mm, con anilla	1300	100	0,291
820961	Toma en T para cinta con goma	400	50	1,060
390916	Empalme cinta hasta 0,45 mm, con anillas	1000	100	0,228
390908	Empalme cinta 22 mm con anillas	450	50	0,428
390906	Unión tubo 16 a cinta hasta 0,45 mm, con anilla	1200	100	0,161
283616	Codo rosca 16x1/2" M con anillas	700	50	0,705
283622	Codo rosca 22x1/2" M con anillas	450	50	0,851
792627	Te rosca 16x1/2"x16 con anillas	350	50	0,781
792628	Te roscada 22x1/2"x22 con anillas	150	50	1,084
792716	Te cinta 16 mm con anilla	250	50	0,777
792722	Te cinta 22 mm con anilla	200	50	1,448

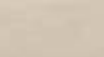
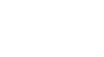

Código	Artículo			€/Ud.
780416	Tapón final cinta 16 con anilla	1400	100	0,271
780422	Tapón final cinta 22 con anilla	800	100	0,387
899967	Válvula cinta/cinta 16 con anilla	350	50	0,804
899969	Válvula cinta/cinta 22 con anilla	250	50	0,840
890116	Vál. Toma con junta x cinta 16 anillas	400	50	0,776
890122	Vál. Toma con junta x cinta 22 anillas	350	50	0,784
899971	Válvula toma layflat x cinta 16 anillas	250	50	0,952
899972	Válvula toma layflat x cinta 22 anillas	250	50	1,071
893516	Válvula 1/2" x cinta 16 anillas	400	50	0,672
893522	Válvula 1/2" x cinta 22 anillas	300	50	0,727
893534	Válvula 3/4" x cinta 22 anillas	250	50	0,727
899761	Válvula tubo 16 x cinta 16 anillas	400	50	0,660



Accesorios cinta

Código	Artículo			€/Ud.
820968	Toma para cinta con goma	800	100	0,323



820941	Toma 9 mm cinta a tubo Pe	1400	100	0,348
--------	---------------------------	------	-----	-------



820948	Toma para cinta	600	100	0,441
450200	Junta bilabial para toma con anillas 16 y 20	600	100	0,128



820616	Toma layflat 16 mm	500	50	0,515
820615	Toma Layflat 16 mm corta	500	50	0,515



820661	Toma layflat con contratuera	400	50	0,759
--------	------------------------------	-----	----	-------



820665	Toma Layflat con salida 1/2"H.	1200	100	0,740
820612	Toma Layflat Blue 1/2"H	0	400	0,544
820667	Toma Layflat 3/4"H	1200	100	0,756



390947	Emplame cinta 16 green	800	100	0,300
390949	Empalme para cinta 16	500	50	0,368
390952	Empalme para cinta 22 mm	350	50	0,627



391216	Empalme cinta a rosca 1/2" M.	700	100	0,324
391225	Empalme cinta a rosca 3/4" M	500	100	0,335
391320	Empalme cinta 22mm a 1/2" M	500	50	0,457
391218	Enlace roscado cinta 1/2"x 16 Blue	700	100	0,260



Código	Artículo			€/Ud.
38505	Adaptador cinta-tubo 16	700	100	0,276



792616	Te 90° para cinta	250	50	0,804
792625	Te roscada 16x1/2"x16 cinta	300	50	0,870



283617	Codo roscado cinta 1/2x16	550	50	0,806
--------	---------------------------	-----	----	-------



780316	Tapón final cinta 16 mm	800	100	0,348
--------	-------------------------	-----	-----	-------



439216	Anilla cierre final cinta	2400	100	0,102
--------	---------------------------	------	-----	-------



899966	Válvula cinta x cinta	250	50	0,851
--------	-----------------------	-----	----	-------



899955	Válvula enlace con junta/cinta	350	50	0,698
--------	--------------------------------	-----	----	-------



891316	Válvula toma layflat x cinta 16	250	50	0,952
--------	---------------------------------	-----	----	-------



899719	Válvula tubo a cinta	350	50	0,660
--------	----------------------	-----	----	-------



899717	Válvula 1/2" x cinta	350	50	0,680
899718	Válvula 3/4" x cinta	300	50	0,680



720000	Sacabocados laiflat, taladro 14 mm	40	1	79,883
501310	Llave inserta- tomas layflat Red	250	25	3,968
501320	Llave inserta-tomas Flat Flow blue	0	1	3,386



Válvulas de descarga

Código	Artículo			€/Ud.
899625	Válv. descarga 3/4" H Naranja presión apertura 0,09 bar	700	100	0,746
899627	Válv. descarga 3/4"H Blanca presión apertura 0,06 bar	700	100	0,746



899601	Válv. descarga 2" M "H" Negra presión apertura 0,5 Bar	20	1	40,564
899602	Válv. descarga 2" M "L" Blanca presión apertura 0,1 Bar	20	1	40,564



Tubo liso

Microtubo Pe

Código	Artículo		€/Ud.
530133	Microtubo manguera Pe. 1 x 3	300	0,1097
530504	Microtubo manguera Pe. 4,5 x 6,5	100	0,1700



Microtubo PVC flexible

Código	Artículo		€/Ud.
529735	Microtubo manguera PVC 3x5	200	0,1925
529246	25 m. Microtubo Flexible 4x6	25	0,4390
529746	Microtubo manguera PVC 4 X 6	200	0,2352
529757	Microtubo manguera PVC 4,5 x 6,5	200	0,2561





Microtubo mando Hidráulico

Código	Artículo			€/Ud.
529681	Microtubo 6x8 Mando Hidráulico Campo	50	200	0,1646
529684	Microtubo 5,5x8 Mando Hidráulico	20	800	0,1570





Tubo liso PE 16 mm, espesor 1,25 mm, color marrón

Código	Artículo			€/Ud.
537002	25 M Pe 16 marrón	180	25	0,4088
537005	50 M Pe 16 marrón	90	50	0,3461
537010	100 M Pe 16 marrón	56	100	0,3231
537016	400 M Pe 16 marrón	12	400	0,2795





Tubo liso PE 16 mm, espesor 1,25 mm

Código	Artículo			€/Ud.
536904	25 M Pe 16 negro	180	25	0,2606
536908	50 M Pe 16 negro	90	50	0,2469
536916	100 M Pe 16 negro	56	100	0,2373
536906	25 M Pe 20 mm negro	100	25	0,3018
536941	Manguera Pe 13,5 x 16	12	400	0,2391
536982	Manguera Pe 17,4 x 20	12	250	0,3383



Tubo PE 32 Agrícola 6 Atm.

Código	Artículo			€/Ud.
532025	25 M Pe 20/6	54	25	0,6203
532050	50 M Pe 20/6	42	50	0,5957
532525	25 M Pe 25/6	48	25	0,8377
532550	50 M Pe 25/6	30	50	0,8216
532599	100 M Pe 25/6	32	100	0,7391
533225	25 M Pe 32/6	28	25	1,4151
533250	50 M Pe 32/6	28	50	1,2347
533299	100 M Pe 32/6	9	100	1,2103
534100	100 M Pe 40/6	1	100	1,8527





Tubo con goteros

Tubo PE con gotero turbulento integrado



Tubo PE 16 mm, con gotero turbulento integrado

Código	Artículo			€/Ud.
512253	25 mts. Pe 16, 2 l. integr. 0,33	180	25	0,4087
512283*	50 mts. Pe 16, 2 l. integr. 0,33	90	50	0,4350
512303	100 mts. Pe 16, 2 l. integr. 0,33	48	100	0,3811
512255	25 mts. Pe 16, 2 l. integr. 0,50	180	25	0,3757
512285*	50 mts. Pe 16, 2 l. integr. 0,50	90	50	0,4101
512305	100 mts. Pe 16, 2 l. integr. 0,50	48	100	0,3563

* Disponible hasta agotar existencias



Tubo PE 16 mm, marrón con gotero turbulento integrado

Código	Artículo			€/Ud.
517025	25 mts. Ris Pe 16, 2 l. 0,33 marrón	180	25	0,5122
517100	100 mts. Ris Pe 16, 2 l. 0,33 marrón	48	100	0,4162
517400	400 mts. Ris Pe 16, 2 l. 0,33 marrón	12	350	0,3751
518025	25 mts. Ris Pe 16, 2 l. 0,50 marrón	180	25	0,4554
518100	100 mts. Ris Pe 16, 2 l. 0,50 marrón	48	100	0,3914
518400	400 mts. Ris Pe 16, 2 l. 0,50 marrón	12	400	0,3182



RIS Classic con gotero turbulento integrado



Ris Classic 16 mm, espesor 1,0 mm

Código	Artículo			€/Ud.
516031	Ris Classic 16/1, sep. 30 cm. 1,6 lph	12	350	0,2766
516032	Ris Classic 16/1, sep. 30 cm. 2,2 lph	12	350	0,2766
516034	Ris Classic 16/1, sep. 30 cm. 4,0 lph	12	350	0,2766
516035	Ris Classic 16/1, sep. 33 cm. 1,6 lph	12	350	0,2715
516037	Ris Classic 16/1, sep. 33 cm. 2,2 lph	12	350	0,2715
516038	Ris Classic 16/1, sep. 33 cm. 4,0 lph	12	350	0,2715
516042	Ris Classic 16/1, sep. 40 cm. 2,2 lph	12	350	0,2533
516044	Ris Classic 16/1, sep. 40 cm. 4,0 lph	12	350	0,2533
516051	Ris Classic 16/1, sep. 50 cm. 1,6 lph	12	400	0,2385
516052	Ris Classic 16/1, sep. 50 cm. 2,2 lph	12	400	0,2385
516052	Ris Classic 16/1, sep. 50 cm. 2,2 lph	12	400	0,2385
516061	Ris Classic 16/1, sep. 60 cm. 1,6 lph	12	400	0,2330
516062	Ris Classic 16/1, sep. 60 cm. 2,2 lph	12	400	0,2330
516064	Ris Classic 16/1, sep. 60 cm. 4,0 lph	12	400	0,2330
516071	Ris Classic 16/1, sep. 75 cm. 1,6 lph	12	400	0,2274
516072	Ris Classic 16/1, sep. 75 cm. 2,2 lph	12	400	0,2274
516074	Ris Classic 16/1, sep. 75 cm. 4,0 lph	12	400	0,2274
516101	Ris Classic 16/1, sep. 100 cm. 1,6 lph	12	400	0,2218
516102	Ris Classic 16/1, sep. 100 cm. 2,2 lph	12	400	0,2218
516104	Ris Classic 16/1, sep. 100 cm. 4 lph	12	400	0,2218
516122	Ris Classic 16/1, sep. 125 cm. 2,2 lph	12	400	0,2182
516124	Ris Classic 16/1, sep. 125 cm. 4,0 lph	12	400	0,2182
516152	Ris Classic 16/1, sep. 150 cm. 2,2 lph	12	400	0,2162
516154	Ris Classic 16/1, sep. 150 cm. 4,0 lph	12	400	0,2162

Ris Classic 20 mm, espesor 1,2 mm

Código	Artículo			€/Ud.
520032	Ris Classic 20, sep. 30 cm. 2,2 lph	12	250	0,5686
520034	Ris Classic 20, sep. 30 cm. 4,0 lph	12	250	0,5686
520033	Ris Classic 20, sep. 33 cm. 2,2 lph	12	250	0,5461
520042	Ris Classic 20, sep. 40 cm. 2,2 lph	12	250	0,5079
520044	Ris Classic 20, sep. 40 cm. 4,0 lph	12	250	0,5079
520052	Ris Classic 20, sep. 50 cm. 2,2 lph	12	250	0,4641
520054	Ris Classic 20, sep. 50 cm. 4,0 lph	12	250	0,4641
520062	Ris Classic 20, sep. 60 cm. 2,2 lph	12	250	0,4397
520064	Ris Classic 20, sep. 60 cm. 4,0 lph	12	250	0,4397
520072	Ris Classic 20, sep. 75 cm. 2,2 lph	12	250	0,4153
520074	Ris Classic 20, sep. 75 cm. 4,0 lph	12	250	0,4153
520102	Ris Classic 20, sep. 100 cm. 2,2 lph	12	250	0,3909
520104	Ris Classic 20, sep. 100 cm. 4,0 lph	12	250	0,3909
520122	Ris Classic 20, sep. 125 cm. 2,2 lph	12	250	0,3766
520124	Ris Classic 20, sep. 125 cm. 4,0 lph	12	250	0,3766

RIS PC con gotero autocompensante integrado



Ris PC 16 mm, espesor 1,15 mm

Código	Artículo			€/Ud.
524032	Ris PC 16/1,15, sep.30 cm 2,2 lph	12	350	0,5415
524034	Ris PC 16/1,15, sep.30 cm 4,0 lph	12	350	0,5415
524037	Ris PC 16/1,15, sep.33 cm 2,2 lph	12	350	0,5129
524033	Ris PC 16/1,15, sep.33 cm 4,0 lph	12	350	0,5129
524040	Ris PC 16/1,15, sep.40 cm 1,4 lph	12	350	0,4585
524042	Ris PC 16/1,15, sep.40 cm 2,2 lph	12	350	0,4585
524043	Ris PC 16/1,15, sep.40 cm 4,0 lph	12	350	0,4585
524050	Ris PC 16/1,15, sep.50 cm 1,4 lph	12	400	0,4114
524052	Ris PC 16/1,15, sep.50 cm 2,2 lph	12	400	0,4114
524054	Ris PC 16/1,15, sep.50 cm 4,0 lph	12	400	0,4114
524060	Ris PC 16/1,15, sep.60 cm 1,4 lph	12	400	0,3799
524062	Ris PC 16/1,15, sep.60 cm 2,2 lph	12	400	0,3799
524064	Ris PC 16/1,15, sep.60 cm 4,0 lph	12	400	0,3799
524070	Ris PC 16/1,15, sep.75 cm 1,4 lph	12	400	0,3486
524072	Ris PC 16/1,15, sep.75 cm 2,2 lph	12	400	0,3486
524074	Ris PC 16/1,15, sep.75 cm 4,0 lph	12	400	0,3486
524100	Ris PC 16/1,15, sep.100 cm 1,4 lph	12	400	0,3171
524102	Ris PC 16/1,15, sep.100 cm 2,2 lph	12	400	0,3171
524104	Ris PC 16/1,15, sep.100 cm 4,0 lph	12	400	0,3171
524122	Ris PC 16/1,15, sep.125 cm 2,2 lph	12	400	0,2966
524124	Ris PC 16/1,15, sep.125 cm 4,0 lph	12	400	0,2966
524152	Ris PC 16/1,15, sep.150 cm 2,2 lph	12	400	0,2963
524154	Ris PC 16/1,15, sep.150 cm 4,0 lph	12	400	0,2963
524202	Ris PC 16/1,15, sep.200 cm 2,2 lph	12	400	0,2798
524204	Ris PC 16/1,15, sep.200 cm 4,0 lph	12	400	0,2798

Ris PC 20 mm, espesor 1,2 mm

Código	Artículo			€/Ud.
527030*	Ris PC 20/1,2, sep.30 cm 2,3 lph	12	250	0,7268
527031*	Ris PC 20/1,2, sep.30 cm 4,0 lph	12	250	0,7268
527033*	Ris PC 20/1,2, sep.33 cm 2,3 lph	12	250	0,6916
527034*	Ris PC 20/1,2, sep.33 cm 4,0 lph	12	250	0,6916
527042*	Ris PC 20/1,2, sep.40 cm 2,3 lph	12	250	0,6306
527044*	Ris PC 20/1,2, sep.40 cm 4,0 lph	12	250	0,6306
527052*	Ris PC 20/1,2, sep.50 cm 2,3 lph	12	250	0,5720
527054*	Ris PC 20/1,2, sep.50 cm 4,0 lph	12	250	0,5720
527062*	Ris PC 20/1,2, sep.60 cm 2,3 lph	12	250	0,5326
527064*	Ris PC 20/1,2, sep.60 cm 4,0 lph	12	250	0,5326
527072*	Ris PC 20/1,2, sep.75 cm 2,3 lph	12	250	0,4936
527074*	Ris PC 20/1,2, sep.75 cm 4,0 lph	12	250	0,4936
527102*	Ris PC 20/1,2, sep.100 cm 2,3 lph	12	250	0,4542
527104*	Ris PC 20/1,2, sep.100 cm 4,0 lph	12	250	0,4542
527122*	Ris PC 20/1,2, sep.125 cm 2,3 lph	12	250	0,4308
527124*	Ris PC 20/1,2, sep.125 cm 4,0 lph	12	250	0,4308

* Disponible hasta agotar existencias

Ris PC 16 mm, espesor 1,15 mm - Morado

Código	Artículo			€/Ud.
529132	Ris PC 16 a 33 cm,2 lt. Morado 2,2 lph	12	350	0,7447
529152	Ris PC 16 a 50 cm,2 lt. Morado 2,2 lph	12	400	0,5886

Ris PC 16 mm, espesor 1,15 mm - MINIROLLO

Código	Artículo			€/Ud.
513732	Ris PC 16, 100 mts, sep. 33 cms 2,2 lph	48	100	0,7407
513752	Ris PC 16, 100 mts, sep. 50 cms 2,2 lph	48	100	0,5886

RIS PLUS con gotero autocompensante antisucción integrado

RIS PLUS

AGRICULTURA

16 MM | 20 MM

0.20M 0.25M 0.30M 0.35M 0.40M
0.50M 0.60M 0.75M 1.00M 1.25M



RIS PLUS

JARDINERÍA

16 MM

0,33M 0,50M



RisPLUS PC AS 16 mm, espesor 1,0 mm

Código	Artículo			€/Ud.
55201x	Ris PLUS PC AS 16/1,0, sep. 20 cm	12	500	0,5981
55202x	Ris PLUS PC AS 16/1,0, sep. 25 cm	12	500	0,5292
55203x	Ris PLUS PC AS 16/1,0, sep. 30 cm	12	500	0,4603
552037	Ris PLUS PC AS 16/1,0, sep.33 cm 2,0 lph	12	500	0,4528
55204x	Ris PLUS PC AS 16/1,0, sep. 40 cm	12	500	0,4351
55205x	Ris PLUS PC AS 16/1,0, sep. 50 cm	12	500	0,4020
55206x	Ris PLUS PC AS 16/1,0, sep. 60 cm	12	500	0,3677
55207x	Ris PLUS PC AS 16/1,0, sep. 75 cm	12	500	0,3279
55210x	Ris PLUS PC AS 16/1,0, sep. 100 cm	12	500	0,2988
55212x	Ris PLUS PC AS 16/1,0, sep. 125 cm	12	500	0,2939

Ris Plus Jardinería, espesor 1,2 mm

Código	Artículo			€/Ud.
551032	Ris PLUS PC AS 16/1,2 sep.33 cm R25 marrón (2 lph)	180	100	0,6565
551132	Ris PLUS PC AS 16/1,2 sep.33 cm R100 marrón (2 lph)	48	100	0,6182
551532	Ris PLUS PC AS 16/1,2 sep.33 cm R400 marrón (2 lph)	12	400	0,5193
551052	Ris PLUS PC AS 16/1,2 sep.50 cm R25 marrón (2 lph)	180	100	0,6036
551152	Ris PLUS PC AS 16/1,2 sep.50 cm R100 marrón (2 lph)	48	100	0,5588
551552	Ris PLUS PC AS 16/1,2 sep.50 cm R400 marrón (2 lph)	12	400	0,4664



RisPLUS PC AS 20 mm, espesor 1,1 mm

Código	Artículo			€/Ud.
553022	Ris PLUS PC AS 20/1,1, sep. 20 cm 2 lph	12	300	0,6948
553027	Ris PLUS PC AS 20/1,1, sep. 25 cm 2 lph	12	300	0,6095
553032	Ris PLUS PC AS 20/1,1, sep. 30 cm 2 lph	12	300	0,5645
553037	Ris PLUS PC AS 20/1,1, sep.33 cm 2 lph	12	300	0,5506
553042	Ris PLUS PC AS 20/1,1, sep. 40 cm 2 lph	12	300	0,5180
553052	Ris PLUS PC AS 20/1,1, sep. 50 cm 2 lph	12	300	0,4711
553062	Ris PLUS PC AS 20/1,1, sep. 60 cm 2 lph	12	300	0,4381
553072	Ris PLUS PC AS 20/1,1, sep. 75 cm 2 lph	12	300	0,3867
553102	Ris PLUS PC AS 20/1,1, sep. 100 cm 2 lph	12	300	0,3569
553122	Ris PLUS PC AS 20/1,1, sep. 125 cm 2 lph	12	300	0,3453

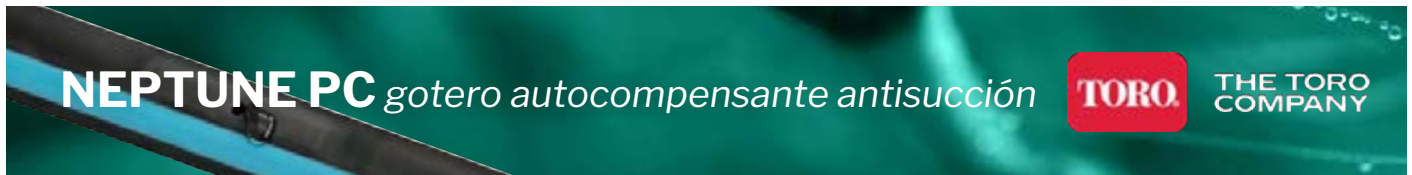





Neptune PC AS 16 x 1,0 mm

Código	Artículo			€/Ud.
558032	Neptun PC AS 16/1,0/30 2,4 lph	12	450	0,5817
558042	Neptun PC AS 16/1,0/40 2,4 lph	12	450	0,5070
558052	Neptun PC AS 16/1,0/50 2,4 lph	12	450	0,4626
558062	Neptun PC AS 16/1,0/60 2,4 lph	12	450	0,4303
558072	Neptun PC AS 16/1,0/75 2,4 lph	12	450	0,3980
558102	Neptun PC AS 16/1,0/100 2,4 lph	12	450	0,3697



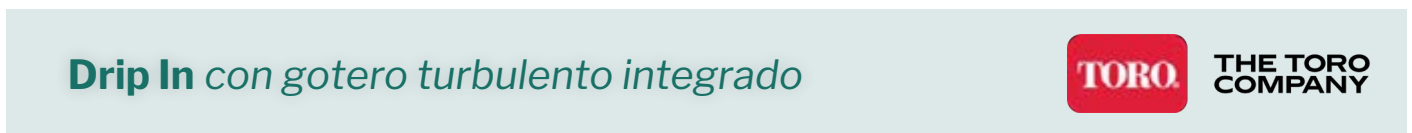

Neptune PC AS 20 x 1,2 mm

Código	Artículo			€/Ud.
567032	Neptun PC AS 20/1,2/30 2,4 lph	12	300	0,6969
567042	Neptun PC AS 20/1,2/40 2,4 lph	12	300	0,6182
567052	Neptun PC AS 20/1,2/50 2,4 lph	12	300	0,5697
567062	Neptun PC AS 20/1,2/60 2,4 lph	12	300	0,5395
567072	Neptun PC AS 20/1,2/75 2,4 lph	12	300	0,5062
567102	Neptun PC AS 20/1,2/100 2,4 lph	12	300	0,4759



Drip In 16 mm, espesor 1,15 mm, con gotero autoc. int. Marrón

Código	Artículo			€/Ud.
515823*	Drip In 16, marrón, 25 mts, sep. 33 cms 2,2 lph	100	25	0,9273
515825*	Drip In 16, marrón, 50 mts, sep. 33 cms 2,2 lph	72	50	0,8609
515832*	Drip In 16, marrón, 100 mts, sep. 33 cms 2,2 lph	48	100	0,7602
529033*	Ris PC 16, marrón, 400 mts, sep. 33 cms 2,2 lph	12	350	0,7447
515751*	Ris PC 16, marrón, 50 mts, sep. 50 cms 2,2 lph	72	50	0,6845
515752*	Ris PC 16, marrón, 100 mts, sep. 50 cms 2,2 lph	48	100	0,6110
529050*	Ris PC 16, marrón, 400 mts, sep. 50 cms 2,2 lph	12	400	0,5886



* Disponible hasta agotar existencias

Goteros para pinchar

Goteros turbulentos

Código	Artículo			€/Ud.
460004	Gotero P.O.	3000	100	0,057
460108	Gotero E-2 8 l/h	10000	1000	0,187
460973	Gotero Euro Key 2 l/h b.azúl	5000	1000	0,177
460996	Gotero Euro Key 4 l/h b.negro	5000	1000	0,177
461002	Gotero Euro Key 8 l/h b.rojo	5000	1000	0,177



Goteros autocompensantes

Código	Artículo			€/Ud.
461074	Gotero Euro Plus 4,6 l/h b.negro	5000	1000	0,176
461078	Gotero Euro Plus 9,2 l/h b.rojo	5000	1000	0,176
461272	Gotero N.G.E. Autoc. 2 l/h b.azul	5000	100	0,173
461273	Gotero N.G.E. Autoc. 3 l/h b.verde	5000	100	0,173
461274	Gotero N.G.E. Autoc. 4 l/h b.negra	5000	100	0,173
461278	Gotero N.G.E. Autoc. 8 l/h b.roja	5000	100	0,173



Goteros autocompensantes antidrenantes

Código	Artículo			€/Ud.
461226	N.G.E. Autoc.Antidrenante 2 l/h b.azul	5000	100	0,173
461239	N.G.E. Autoc.Antidrenante 3 l/h b.verde	5000	100	0,173
461252	N.G.E. Autoc.Antidrenante 4 l/h b.negra	5000	100	0,173
461267	N.G.E. Autoc.Antidrenante 8 l/h b.roja	5000	100	0,173



Black Spider compatibles con NGE

Disponibles White Spider (color blanco) bajo pedido

Código	Artículo			€/Ud.
140160	Black spider 60 cm. 1 salida	5000	100	0,323
140260	Black spider 60 cm. 2 salidas	2500	50	0,636
140060	Black spider 60 cm. 4 salidas	750	25	1,286
140061	Black spider 60 cm. 4 salidas 90°	750	25	1,312
310201	Derivación recta salida simple.	5000	5000	0,055
310202	Derivación en Te para 2 salidas	6000	5000	0,076
310204	Derivación en cruz para 4 salidas	3000	4000	0,124
412040	Estaca laberinto turbulenta recta	1000	1000	0,097
414090	Estaca 90° turbulenta	2000	100	0,092
529735	Microtubo manguera PVC 3x5	0	200	0,193





Estaca capilar

Código	Artículo			€/Ud.
412030	Estaca capilar	3200	800	0,061



Goteros regulables

Código	Artículo			€/Ud.
461016	Gotero regulable Variflow R	4000	100	0,058
461014	Gotero regulable Variflow	1000	100	0,089



461024	Varistake regulable	1500	100	0,369
--------	---------------------	------	-----	-------





Microaspersión

Microjets

Código	Artículo			€/Ud.
109036	Microdifusor Centurion 360° Negro	10000	100	0,158
109018	Microdifusor Centurion 180° Gris	10000	100	0,158
109009	Microdifusor Centurion 90° Verde	10000	100	0,158



Varijet

Código	Artículo			€/Ud.
108109	Microaspersor Varijet 90 °	1000	100	0,505
108118	Microaspersor Varijet 180 °	1000	100	0,505
108136	Microaspersor Varijet 360 °	1000	100	0,505
55030	Prolongación rígida 30 cm	1000	100	0,490



Miniwater

Código	Artículo			€/Ud.
118836	Aspersor Miniwater 360°	2000	50	0,385
300736	Kit microaspersor miniwater	250	10	0,767



WaterBird®

THE TORO
COMPANY

Microaspersores WaterBird® VI

Código	Artículo			€/Ud.
116447	Microaspor Waterbird VI	1500	50	0,919

Microaspersores WaterBird® VII PC Autocompensante

Código	Artículo			€/Ud.
117236	Microas. Waterbird VII PC Marrón 36 lph	1500	50	1,817
117247	Microas. Waterbird VII PC Azul 47 lph	1500	50	1,817

Accesorios Water Bird®

Código	Artículo			€/Ud.
41091	Adaptador para Waterbird 5 mm	1000	50	0,165
41096	Adaptador para Waterbird 6 mm	1000	50	0,165
411039	Estaca para Waterbird 40 cms.	300	50	0,316
900008	Varilla metálica 6 mm x 80 cm Water Bird	50	25	1,070
300605	Kit WB adap 5 mm +60 cm tubo + toma	1000	50	0,352
300606	Kit WB adap 6 mm +60 cm tubo + toma	1000	50	0,352



Ein Dor microaspersión

Micro Ein Dor 861

Código	Artículo			€/Ud.
574035	Microas. 861 35 lph. Azul claro	3000	1500	0,781
574050	Microas. 861 50 lph. Morado	3000	1500	0,781
574070	Microas. 861 70 lph. Negro.	3000	1500	0,781
574105	Microas. 861 105 lph. Azul oscuro	3000	1500	0,781



Kit Micro 861 60 cm + estaca + tomas

Código	Artículo			€/Ud.
301403	Kit 861R 35 lph	300	300	1,909
301405	Kit 861R 50 lph	300	300	1,909
301407	Kit 861R 70 lph	300	300	1,909
301410	Kit 861R 105 lph	300	300	1,909



Micro Ein Dor 866 riego invertido

Código	Artículo			€/Ud.
576035	Microas. 866 35 lph. Azul claro.	3000	1500	0,781
576050	Microas. 866 50 lph. Morado.	3000	1500	0,781
576070	Microas. 866 70 lph. Negro.	3000	1500	0,781
576090	Microas. 866 90 lph. Verde oscuro.	3000	1500	0,781
576120	Microas. 866 120 lph. Rojo	3000	1500	0,781



Kit 866 60 cm + antigoteo

Código	Artículo			€/Ud.
737003	Kit 866,35l 0,60 cm + antigota	250	250	2,948
737005	Kit 866,50l 0,60 cm + antigota	250	250	2,948
737007	Kit 866,70l 0,60 cm + antigota	250	250	2,948
737009	Kit 866,90l 0,60 cm + antigota	250	250	2,948
737012	Kit 866,120l 0,60 cm + antigota	250	250	2,948



Micro Ein Dor 850 180° 50 lts.

Código	Artículo			€/Ud.
575105	Microaspersor 850 Sectorial 50 lph	5000	2500	0,790



Kit 850, 60 cm + estaca + tomas

Código	Artículo			€/Ud.
301205	Kit 850, 50 lph	0	300	1,906



Mist Ein Dor 4191, 20 lph

Código	Artículo			€/Ud.
568020	Mister 4191, 20 lph.	5000	2500	0,513
568035	Mister 4191, 35 lph.	5000	2500	0,513



Kit 4194, 20l, 30 cm + antigoteo

Código	Artículo			€/Ud.
736020	Kit 4191, 20 lph 30 cm + antigota	300	300	2,494
736035	Kit 4191, 35 lph 30 cm + antigota	300	300	2,494



Nebulizador dinámico Ein Dor 700, 40 lph

Código	Artículo			€/Ud.
575040	Mist 700, 40 lph. Gris	5000	100	0,375
575070	Mist 700, 70 lph. Negro	5000	100	0,375



Kit 700, 40 l. 30 cm + antigota

Código	Artículo			€/Ud.
301040	Kit 700, 40 l/h. 60 cm	300	300	1,675



Nebulizador Ein Dor Fogger 4 lts.

Código	Artículo			€/Ud.
599904	Fogger 4 lph	5000	2500	0,958



Kit Fogger, 30 cm + antigota

Código	Artículo			€/Ud.
738001	Kit Fogger 1 salidas 30 cm	150	150	3,379
738002	Kit Fogger 2 salidas 30 cm	150	150	5,069
738004	Kit Fogger 4 salidas 30 cm	150	150	6,758



Válvulas antigoteo

Código	Artículo			€/Ud.
892051	Válvula Antigoteo 530L,1,1 Atm	4000	2000	1,200
892052	Válvula Antigoteo 530H, 1,5 Atm.	4000	2000	1,200
892047	Válvula antigoteo	500	50	2,058



Accesorios Ein Dor

Código	Artículo			€/Ud.
820001	Toma 5 mm hembra.	15000	7000	0,087
820002	Toma 5 mm macho	20000	10000	0,085
820003	Toma doble 5 mm	20000	10000	0,087
390006	Nipple doble M-M	20000	10000	0,108
410025	Estabilizador 38 G	600	600	0,657
855647	Tubo PVC 4x7 60 cm M/H	500	500	0,649



Aspersores aéreos

Aspersor 920

Código	Artículo			€/Ud.
578180	Asp 920 180 l. 1/2" M	800	400	4,051
578240	Asp 920 240 l.1/2" M	800	400	4,051
578400	Asp 920 400 l. 1/2" M	800	400	4,051



RIS AQ *aspersión aérea*

Aspersores RIS AQ 1/2"

Código	Artículo			€/Ud.
113522	Asp. RIS AQ 22 (2,5 x Tapón)	150	25	3,333
113523	Asp. RIS AQ 22 (2,5 x 1,8)	150	25	3,333
113520	Asp. RIS AQ 22 PC (2,5xtapón)	150	25	7,222
100023	Tobera secundaria AQ 22 (1,8 mm) Morada	50	50	0,424



300012	Conjunto 120 mm.Tubo PVC+adap.+toma	100	25	1,587
900012	Varilla galvanizada 120 cms.	50	25	2,058
300008	Conexión Hembra	100	100	0,251
300007	Conexión macho	100	100	0,251
780000	Tapón cónico	100	100	0,250
536893	Tubo Pe 9x13 mm R 100	100	100	0,774

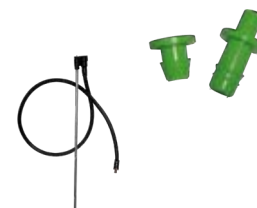



Aspersores RIS AQ 3/4"

Código	Artículo			€/Ud.
113546	Asp. RIS AQ 46 (3,96x2,38mm)	80	22	4,11
113549	Asp. RIS AQ 46 (4,76x2,38) Tob latón	80	22	4,35
113548	Asp. RIS AQ 46 PC (3,96x2,38)	80	22	8,22
113544	Asp. RIS AQ 46 PC (4,76x2,38) Tob latón	80	22	10,16





Aspersores SIME

Código	Artículo			€/Ud.
115721	Asp Junior circular 1/2" M	80	80	18,55
115722	Asp Junior sectorial 1/2" M	75	75	22,83
115743	Asp Silver sectorial 3/4" M	35	35	42,80
115719	Asp Funny circular 1"	30	30	45,65
115718	Asp Funny sectorial 1"	25	25	61,34
115717	Asp Ibis circular 1"	20	20	55,64
115716	Asp Ibis sectorial 1"	20	20	68,48
293025	Asp Jolly circular 1 1/4"	18	18	78,46
293022	Asp Jolly sectorial 1 1/4"	16	16	99,86
115715	Asp Ambo circular 1 1/2"	20	20	94,16
115714	Asp Ambo Sectorial 1 1/2"	17	17	122,69
115705	Asp Hidra circular 1 1/2"	9	9	146,94
115704	Asp Hidra sectorial 1 1/2"	8	8	171,19
115738	Asp Duplex circular 2"	5	5	262,50
115737	Asp Duplex sectorial 2"	4	4	338,11
115730	Asp Senior sectorial 2"	4	4	340,96



Accesorios de riego

Manómetros glicerina

Código	Artículo			€/Ud.
550102	Manometro Glicerina 6 atm.	50	1	11,11
550113	Manometro Glicerina 10 atm.	50	1	11,11



Código	Artículo			€/Ud.
700001	Toma manómetro 1/4" R Macho	100	25	0,96
700003	Toma Manómetro pinchar 3 mm	100	25	0,96



Ventosas

Código	Artículo			€/Ud.
900303	Ventosa Plastico 1/2" Rosca M	100	100	3,08
900532	Ventosa VBK 1" simple efecto	180	10	10,42
900291	Ventosa 1/2" cinética Simple efecto	1	1	10,86
900293	Ventosa 3/4" cinética Simple efecto	20	20	10,86
900301	Ventosa 1" cinética Simple efecto	1	1	17,07
900302	Ventosa 2" cinética Simple efecto	8	1	31,30



Código	Artículo			€/Ud.
900416	Ventosa 1/2" Automática, doble efecto	50	1	11,58
900425	Ventosa 3/4" Automática, doble efecto	50	1	11,58
900432	Ventosa 1" Automática, doble efecto	20	1	18,20
900464	Ventosa 2" Automática. Doble efecto	8	1	34,05



Útiles para goteo

Código	Artículo			€/Ud.
306040	Cortatubos hasta 32 mm	1	1	17,28
306063	Cortatubos hasta 63 mm	1	1	22,50
721006	Sacabocados punzón	100	100	0,56
725003	Sacabocados con expulsor (3 mm)	10	10	6,88



Código	Artículo			€/Ud.
720030	Sacabocados 3 mm. Tenaza para PE 16/20	15000	500	21,404
720001	Inserta tomas micro-tubo	1	1	42,75



Válvulas de descarga final

Código	Artículo			€/Ud.
899625	Válv. descarga 3/4" H Naranja presión apertura 0,09 bar	700	100	0,75
899627	Válv. descarga 3/4"H Blanca presión apertura 0,06 bar	700	100	0,75



Código	Artículo			€/Ud.
899602	Válv. descarga 2" M "L" Blanca presión apertura 0,1 Bar	20	1	40,56
899601	Válv. descarga 2" M "H" Negra presión apertura 0,5 Bar	20	1	40,56



Accesorios microtubo

Código	Artículo			€/Ud.
820103	Conexión microtubo 3 x 4,5 mm	27000	500	0,037
820407	Conexión microtubo 6,5 mm.	52000	2000	0,112
795580	Te 3,5 mm	15000	500	0,084
899704	Válvula microtubo 6 x 8	100	100	1,480



Accesorios dentado para goteo

Código	Artículo			€/Ud.
821016	Toma dentada Ø 16 mm.	2400	100	0,054
821020	Toma dentada Ø 20 mm.	700	100	0,083
450218	Goma toma dentada 16-20	3000	100	0,111



390116	Empalme dentado 16 mm	1800	100	0,049
390120	Empalme dentado 20 mm	1800	100	0,089
390161	Empalme reducido 16-12	1100	100	0,100
390201	Empalme reducido 20-16	600	100	0,159



391616	Enlace rosca 1/2" x 16	1200	100	0,143
391620	Enlace rosca 3/4" x 16	1000	100	0,143
391621	Enlace rosca 1/2" x 20	300	100	0,297
391622	Enlace rosca 3/4" x 20	300	100	0,297





391116	Enlace rosca Hembra 1/2" x 16	200	100	0,362
391125	Enlace rosca Hembra 3/4" x 16	200	100	0,510



791516	Te 16 mm	800	100	0,148
791520	Te 20 mm	800	100	0,296
791816	Te mixta 16x1/2x16	750	100	0,270
791825	Te mixta 16x3/4x16	600	100	0,278



Código	Artículo			€/Ud.
286616	Codo 16 mm	1400	100	0,159
286620	Codo 20 mm	1400	100	0,275
286741	Codo 1/2" x 16 mm	600	100	0,249
286743	Codo 3/4" x 16 mm	1000	100	0,256



780105	Tapon Pe 4 mm.	1000	1000	0,034
780163	Tapon Pe 6 mm.	1000	1000	0,034



780216	Tapón 16 mm	1600	100	0,063
--------	-------------	------	-----	-------



367016	Anilla doble de cierre 16 mm	2300	100	0,094
367020	Anilla doble de cierre 20 mm	2800	200	0,078



440003	Gancho 16 x 30	5000	5000	0,062
440009	Gancho 16 x 90	2000	2000	0,106
440016	Gancho 16 x 160	2000	2000	0,117



635016	Piqueta sujección Pe 16 mm	400	400	0,181
635020	Piqueta sujección Pe 20 mm	400	400	0,181



2016	Abrazadera de seguridad 16 mm	1800	100	0,073
1616	Abrazadera tapón para integrado 16 mm	1200	100	0,154



Accesorios de goteo con anillas

Código	Artículo			€/Ud.
820636	Toma Layflat a Pe 16 mm	500	50	0,658



820716	Toma con anillas Ø 16 mm.	500	100	0,139
820720	Toma con anillas Ø 20 mm.	400	100	0,163



450200	Junta bilabial para toma con anillas 16 y 20	600	100	0,128
--------	--	-----	-----	-------



820718	Toma con junta Ø 16 mm	1500	100	0,226
820580	Toma con junta Ø 20 mm.	1200	100	0,256



390416	Empalme con anillas 16 mm.	1600	100	0,156
390520	Empalme con anillas 20 mm.	1000	100	0,189
390521	Enlace reducido 20 x 16 con anilla	1000	100	0,181



286516	Codo con anillas 16 mm	1000	100	0,246
286520	Codo con anillas 20 mm	1000	100	0,246
286742	Codo anillas 1/2" x 20	1000	100	0,345
286744	Codo anillas 3/4" x 20	1000	100	0,360



Código	Artículo			€/Ud.
--------	----------	--	--	-------

791616	Te con anillas 16 mm	1000	100	0,230
792020	Te con anillas 20 mm	1000	100	0,246



792016	Te reducida 20x16x20 anillas	1000	100	0,279
--------	------------------------------	------	-----	-------



791620	Te reducida 16 x 20 x 16 anillas	1000	100	0,328
--------	----------------------------------	------	-----	-------

791618	Te mixta 16 x1/2x16 anillas	1000	100	0,345
--------	-----------------------------	------	-----	-------



792018	Te mixta 20x1/2x20 anillas	1000	100	0,345
--------	----------------------------	------	-----	-------

792019	Te mixta 20x3/4x20 anillas	1000	100	0,360
--------	----------------------------	------	-----	-------

391614	Enlace mixto 1/2"Mx16 anillas	1100	100	0,323
--------	-------------------------------	------	-----	-------

391618	Enlace mixto 3/4"Mx16 anillas	800	100	0,335
--------	-------------------------------	-----	-----	-------

391623	Enlace mixto 1/2"Mx20 anillas	800	100	0,341
--------	-------------------------------	-----	-----	-------

391624	Enlace mixto 3/4"Mx20 anillas	700	100	0,353
--------	-------------------------------	-----	-----	-------



Accesorios de goteo de color marrón

Código	Artículo			€/Ud.
820416	Toma PVC con goma 16 mm	800	100	0,333
820420	Toma PVC con goma 20 mm	600	100	0,375
820816	Toma 16 mm marrón con junta	800	100	0,333
820817	Toma con goma 17 mm marrón.	3600	100	0,185



390317	Empalme 17 mm marrón	1500	100	0,126
390216	Empalme M 16 mm	1800	100	0,115
390220	Empalme M 20 mm	1000	100	0,153



391516	Enlace rosca M 1/2" x 16	600	100	0,195
391520	Enlace rosca M 3/4" x 16	1000	100	0,195



Código	Artículo			€/Ud.
--------	----------	--	--	-------

286716	Codo 16 mm Marrón	600	100	0,233
295016	Cruz 16 mm Marrón	500	100	0,382



791416	Te 16 mm Marrón	800	100	0,271
--------	-----------------	-----	-----	-------

791718	Te mixta Marrón 16x1/2x16	750	100	0,292
--------	---------------------------	-----	-----	-------



286843	Codo marron 3/4"x16	1000	100	0,346
--------	---------------------	------	-----	-------



Válvulas goteo

Código	Artículo			€/Ud.
899950	Válvula toma con junta a tubo 16	500	50	0,632
899952	Válvula toma con junta a tubo 20	400	50	0,632



899716	Válvula VPP 16 mm	450	50	0,595
899720	Válvula VPP 20 mm	350	50	0,595



Código	Artículo			€/Ud.
--------	----------	--	--	-------

899816	Válvula VMP 1/2" x 16mm	450	50	0,602
--------	-------------------------	-----	----	-------

899819	Válvula VMP 1/2" x 20 mm	450	50	0,602
--------	--------------------------	-----	----	-------

899817	Válvula VMP 3/4" x 16 mm	400	50	0,602
--------	--------------------------	-----	----	-------

899820	Válvula VMP 3/4" x 20 mm	350	50	0,602
--------	--------------------------	-----	----	-------

899825	Válvula VMP 3/4" x 25 mm	300	50	0,650
--------	--------------------------	-----	----	-------





899801	Válvula VPP 16 mm con anillas	450	50	0,747
--------	-------------------------------	-----	----	-------



899802	Válvula VPP 20 mm con anillas	350	50	0,830
--------	-------------------------------	-----	----	-------



Collarines

Código	Artículo			€/Ud.
294112	Collarín de toma 20 x 1/2"	150	1	1,17
294212	Collarín de toma 25 x1/2"	150	1	1,11
294234	Collarín de toma 25 x3/4"	150	1	1,11
294312	Collarín de toma 32 x 1/2 "	110	1	1,35
294334	Collarín de toma 32 x 3/4 "	110	1	1,35
294936	Collarín de toma 32 x 1 "	110	1	1,55
294412	Collarín de toma 40 x 1/2 "	110	1	1,61
294434	Collarín de toma 40 x 3/4"	100	1	1,61
294432	Collarín de toma 40 x 1"	100	1	1,61
294512	Collarín de toma 50 x 1/2"	90	1	1,70
294534	Collarín de toma 50 x 3/4"	90	1	1,70
294543	Collarín de toma 50 x 1"	90	1	1,70



Código	Artículo			€/Ud.
294612	Collarín de toma 63 x 1/2"	45	1	2,52
294634	Collarín de toma 63 x 3/4"	45	1	2,52
294664	Collarín de toma 63 x 1"	45	1	2,52
294670	Collarín de toma 63 x1 1/4"	45	1	2,64
294665	Collarín de toma 63 x1 1/2"	45	1	2,64
294672	Collarín de toma 75 x1/2"	40	1	3,52
294674	Collarín de toma 75 x3/4"	40	1	3,52
294675	Collarín de toma 75 x1"	40	1	3,52
294676	Collarín de toma 75 x 11/4 "	35	1	3,52
294677	Collarín de toma 75 x 11/2 "	30	1	3,81
294678	Collarín de toma 75 x 2 "	30	1	3,81
294692	Collarín de toma 90 x3/4"	60	1	4,67
294689	Collarín de toma 90 x1"	55	1	4,67
294690	Collarín de toma 90 x 11/4 "	55	1	4,67
294688	Collarín de toma 90 x 11/2 "	55	1	4,67
294691	Collarín de toma 90 x 2 "	55	1	5,24
294679	Collarín de toma 110 x 1"	55	1	5,05
294687	Collarín de toma 125 x 1"	45	1	11,97



Accesorio roscado

Código	Artículo			€/Ud.
563016	Machón 1/2" X 1/2"	1500	50	0,36
563025	Machón 3/4" X 3/4"	1400	50	0,43
563032	Machón 1" X 1"	800	50	0,55
563040	Machón 1 1/4" X 1 1/4"	375	25	0,84
563050	Machón 1 1/2" X 1 1/2"	250	25	1,09
563063	Machón 2" X 2"	150	25	1,39
563075	Machón 2 1/2" X 2 1/2"	96	12	2,20
563090	Machón 3" X 3"	60	12	3,23



Código	Artículo			€/Ud.
554012	Manguito unión 1/2"	1400	50	0,63
554025	Manguito unión 3/4"	900	50	0,88
554032	Manguito unión 1"	500	50	1,28
554040	Manguito unión 1 1/4"	250	25	2,02
554050	Manguito unión 1 1/2"	225	15	1,86
554064	Manguito unión 2"	144	12	2,37
554075	Manguito unión 2 1/2"	120	12	3,37
554090	Manguito unión 3"	60	6	4,25



564216	Machón reducido 3/4" X 1/2"	1500	50	0,36
564325	Machón reducido 1" X 3/4"	1000	50	0,46
564416	Machón reducido 1 1/4" X 1/2"	450	25	0,78
564425	Machón reducido 1 1/4" X 3/4"	450	25	0,78
564432	Machón reducido 1 1/4" X 1"	450	25	0,84
564525	Machón reducido 1 1/2" X 3/4"	300	25	1,15
564532	Machón reducido 1 1/2" X 1"	300	25	1,19
564540	Machón reducido 1 1/2" X 1 1/4"	250	25	1,24
564632	Machón reducido 2" X 1"	200	25	1,50
564640	Machón reducido 2" X 1 1/4"	175	25	1,60
564650	Machón reducido 2" X 1 1/2"	175	25	1,59
564763	Machón reducido 2 1/2" X 2"	108	12	2,43
564945	Machón reducido 3" x 2"	96	12	3,14
564950	Machón reducido 3" X 2 1/2"	72	12	3,18



554525	Manguito reducido 3/4" x 1/2"	1000	50	0,98
554532	Manguito reducido 1" x 3/4"	600	50	1,30
554540	Manguito reducido 1 1/4" x 1"	275	25	1,83
554550	Manguito reducido 1 1/2" x 1 1/4"	240	15	1,69
554564	Manguito reducido 2" x 1 1/2"	168	12	2,45
554575	Manguito reducido 2 1/2" x 2"	120	12	3,22
554590	Manguito reducido 3" x 2"	84	6	3,81
554595	Manguito reducido 3" x 2 1/2" H	72	6	3,951



700613	Tuerca reducida 1/2" X 1/4"	1150	50	0,70
862516	Tuerca reducida 3/4" X 1/2"	1900	50	0,56
863225	Tuerca reducida 1" X 3/4"	1300	50	0,63
864032	Tuerca reducida 1 1/4" X 1"	600	25	0,98
865032	Tuerca reducida 1 1/2" X 1"	360	15	1,30
865040	Tuerca reducida 1 1/2" X 1 1/4"	300	15	1,42
866450	Tuerca reducida 2" X 1 1/2"	255	15	1,64
867563	Tuerca reducida 2 1/2" x 2"	144	12	2,32
869075	Tuerca reducida 3" x 2 1/2"	96	12	2,80



287016	Codo 1/2 " H	800	25	0,88
287025	Codo 3/4 " H	450	25	1,22
287032	Codo 1" H	300	25	1,44
287040	Codo 1 1/4" H	180	15	2,23
287050	Codo 1 1/2" H	110	10	3,41
287064	Codo 2" H	66	6	4,74
287075	codo 2 1/2" H	36	4	8,25
287090	Codo 3" H	26	2	11,91



782016	Tapón roscado 1/2" M	2000	50	0,338
782025	Tapón roscado 3/4" M	1800	50	0,387
782032	Tapón roscado 1" M	1200	50	0,479



NEVO

785016	Te 1/2 " H	450	25	1,29
785025	Te 3/4 " H	275	25	1,96
785032	Te 1" H	200	25	2,29
785040	Te 1 1/4" H	105	15	3,08
785050	Te 1 1/2" H	60	10	5,17
785064	Te 2" H	42	6	7,09
785075	Te 2 1/2" H	27	3	10,97
785096	Te 3" H	18	2	15,01





Accesorio de presión para polietileno

Código	Artículo			€/Ud.
287725	Codo 25x25x1/2"	160	10	2,84
287732	Codo 32x32x3/4"	100	10	3,47

392120	Enlace rosca macho 20 x 1/2"	800	50	0,57
392125	Enlace rosca macho 25 x 3/4"	500	25	0,74
392132	Enlace rosca macho 25 x 1"	450	25	0,74
392225	Enlace rosca macho 32x3/4"	325	25	1,01
392232	Enlace rosca macho 32 x 1"	300	25	0,78
392340	Enlace rosca macho 40 x 11/4"	165	15	1,53
392450	Enlace rosca macho 50 x 11/2"	100	10	2,50
392564	Enlace rosca macho 63 x 2"	66	6	3,07
392680	Enlace rosca macho 75 x 2 1/2"	32	4	6,74
392790	Enlace rosca macho 90 x 3"	24	4	7,92

392016	Enlace rosca hembra 20 x 1/2"	650	50	0,75
392020	Enlace rosca hembra 20 x 3/4"	600	50	0,83
392025	Enlace rosca hembra 25 x 3/4"	425	25	0,99
392032	Enlace rosca hembra 32 x 1"	250	25	1,27
392040	Enlace rosca hembra 40 x 11/4"	150	15	2,23
392050	Enlace rosca hembra 50 x 11/2"	100	10	2,89
392064	Enlace rosca hembra 63 x 2"	60	6	4,24
392077	Enlace rosca hembra 75 x 21/2"	32	4	8,06
392090	Enlace rosca hembra 90 x 3"	20	4	11,57



Código	Artículo			€/Ud.
287120	Codo 90° 20 mm	400	25	1,11
287125	Codo 90° 25 mm	255	15	1,43
287132	Codo 90° 32 mm	160	10	1,42
287140	Codo 90° 40 mm	85	5	3,28
287150	Codo 90° 50 mm	48	4	5,14
287164	Codo 90° 63 mm	32	4	5,61
287175	Codo 90° 75 mm	16	2	13,82
287190	Codo 90° 90 mm	12	1	15,73

287520	Codo rosca hembra 20 x 1/2"	500	25	0,87
287525	Codo rosca hembra 25 x 3/4"	345	15	1,23
287530	Codo rosca hembra 32 x 3/4"	240	10	1,68
287532	Codo rosca hembra 32 x 1"	200	10	1,75
287544	Codo rosca hembra 40x11/4"	100	5	2,89
287555	Codo rosca hembra 50x11/2"	72	4	4,09
287564	Codo rosca hembra 63x2"	48	4	5,95
287575	Codo rosca hembra 75x21/2"	24	2	10,52
287590	Codo rosca hembra 90x3"	17	1	15,24

287220	Codo rosca macho 20 x 1/2"	650	25	0,51
287225	Codo rosca macho 25 x 3/4"	390	15	1,03
287230	Codo rosca macho 32 x 3/4"	260	10	1,56
287232	Codo rosca macho 32 x 1"	240	10	1,54
287244	Codo rosca macho 40x11/4"	130	5	2,51
287255	Codo rosca macho 50x11/2"	80	4	3,61
287264	Codo rosca macho 63x2"	48	4	5,16
287272	Codo rosca macho 75x21/2"	26	2	9,61
287293	Codo rosca macho 90x3"	18	1	13,79



Accesorio de presión para polietileno

Código	Artículo			€/Ud.
784920	Te igual 90° 20 mm	240	15	1,67
784925	Te igual 90° 25 mm	150	10	2,06
784932	Te igual 90° 32 mm	100	5	2,82
784940	Te igual 90° 40 mm	50	5	4,50
784950	Te igual 90° 50 mm	36	4	6,85
784964	Te igual 90° 63 mm	24	3	8,36
784975	Te igual 90° 75 mm	11	1	18,45
784990	Te igual 90° 90 mm	8	1	26,99



Código	Artículo			€/Ud.
390620	Manguito unión 20 mm	400	25	0,71
390625	Manguito unión 25 mm	275	25	0,99
390632	Manguito unión 32 mm	180	10	1,24
390640	Manguito unión 40 mm	100	10	2,53
390650	Manguito unión 50 mm	66	6	3,38
390664	Manguito unión 63 mm	40	5	4,89
390675	Manguito unión 75 mm	18	2	8,69
390690	Manguito unión 90 mm	14	2	13,00



784820	Te 20 x 3/4" x 20	270	15	1,77
784825	Te 25 x 3/4" x 25	180	10	1,96
784830	Te 32 x 3/4" x 32	130	10	2,66
784832	Te 32 x 1" x 32	120	10	2,63
784840	Te 40 x 1 1/4" x 40	60	5	4,27
784841	Te 40 x 1" x 40	70	5	3,90
784850	Te 50 x 1 1/2" x 50	44	4	6,16
784864	Te 63 x 2" x 63	27	3	8,59
784875	Te 75 x 2 1/2" x 75	15	1	15,97
784890	Te 90 x 3" x 90	10	1	23,68



390820	Manguito reducido 25 x 20	350	25	1,39
390825	Manguito reducido 32 x 25	220	10	1,83
390832	Manguito reducido 40 x 32	120	10	2,53
390840	Manguito reducido 50 x 40	78	6	4,25
390850	Manguito reducido 63 x 50	48	6	5,75
390863	Manguito reducido 75 x 63	28	2	10,74
390875	Manguito reducido 90 x 75	16	2	16,88



781620	Tapón final 20 mm	800	50	0,62
781625	Tapón final 25 mm	550	25	0,77
781632	Tapón final 32 mm	350	25	1,03
781640	Tapón final 40 mm	195	15	1,54
781650	Tapón final 50 mm	120	12	2,50
781664	Tapón final 63 mm	84	6	3,84
781675	Tapón final 75 mm	40	4	7,39
781690	Tapón final 90 mm	24	4	9,84



Llaves para accesorio de polietileno

Código	Artículo			€/Ud.
501240	Llave de apriete pe 20-40	1	1	5,60
501265	Llave de apriete pe 40-63	1	1	17,65
501290	Llave de apriete pe 63-100	1	1	23,30





**Versátil.
Sencillo.
Eficiente.**



Válvulas plástico

Ris-Valves básicas plástico

Código	Artículo			€/Ud.
892910	Válvula básica Plástico 1"	20	20	26,32
891513	Vál. Serie HE Plásti 1 1/2"R	180	6	36,45
891518	Vál. Serie HE Plásti 2"R	180	6	36,45
891524	Vál. Serie HE Plásti 2 1/2"R	160	4	43,47
891533	Vál. Serie HE Plásti 3"R	70	2	73,72
891549	Vál. Serie HE Plásti 4"R	72	4	109,56
891542	Vál. Serie HE Plásti 4"R PN 4	72	4	92,561
891552	Vál. Serie HE Plásti 4" victaulic	72	4	109,560
891545	Vál. Serie HE Plásti 4" Brida	72	1	154,226



Ris-Valves plástico con mando manual

Código	Artículo	€/Ud.	Código	Artículo	€/Ud.
891560	Vál. + mando manual Plásti 1 1/2"R	60,23	891565	Vál. + mando manual Plásti 4"R	133,95
891561	Vál. + mando manual Plásti 2"R	60,23	891564	Vál. + mando manual Plásti 4"R PN4	116,95
891562	Vál. + mando manual Plásti 2 1/2"R	67,25	891566	Vál. + mando manual Plásti 4"VIC	133,95
891563	Vál. + mando manual Plásti 3"R	97,50	891567	Vál. + mando manual Plásti 4"Brida	178,62



Electroválvulas NC latch plástico

Código	Artículo	€/Ud.	Código	Artículo	€/Ud.
891570	Electroválvula latch Plásti 1 1/2"R	88,00	891575	Electrovalvula latch Plásti 4"R	163,19
891571	Electroválvula latch Plásti 2"R	88,00	891574	Electrovalvula latch Plásti 4"R PN4	147,10
891572	Electroválvula latch Plásti 2 1/2"R	95,02	891576	Electrovalvula latch Plásti 4"VIC	164,10
891573	Electrovalvula latch Plásti 3"R	125,27	891577	Electrovalvula latch Plásti 4"Brida	208,77



Electroválvulas NC 24 VAC plástico

Código	Artículo	€/Ud.	Código	Artículo	€/Ud.
891715	Electroválvula 24V Plásti 1 1/2"R	85,21	891740	Electrovalvula 24V Plásti 4"R	160,40
891720	Electroválvula 24V Plásti 2"R	85,21	891744	Electrovalvula 24V Plásti 4"R PN4	143,42
891725	Electroválvula 24V Plásti 2 1/2"R	92,23	891746	Electrovalvula 24V Plásti 4" VIC	160,42
891730	Electrovalvula 24V Plásti 3"R	122,47	891745	Electrovalvula 24V Plásti 4"Brida	205,09



Todos los códigos de válvulas con pilotaje son para válvula normalmente cerrada, e incluyen:

- Fitting de tipo automático
- Solenoide de 3 vías RS100X - NO
- Piloto Plástico PN10 de 3 vías y 5.5 bar Máx. salida

Para otras configuraciones, como válvula normalmente abierta o solenoide y piloto de 2 vías entre otros, consultar diferentes posibilidades en el apartado de kits para válvulas hidráulicas.

Posibilidad de adaptar todos los modelos a conexión victaulic. Por motivos de transporte, las válvulas pilotadas se entregan con válvula y kit por separado. Para otras opciones, consultar.

Electroválvulas NC reductoras plástico

Código	Artículo	€/Ud.	Código	Artículo	€/Ud.
891815	Electrov 24V Reductora Plásti 1 1/2"R	140,78	891840	Electrov 24VReductora Plásti 4"R	217,41
891820	Electrov 24V reductora Plásti 2"R	140,78	891844	Electrov 24VReductora Plásti 4"R PN4	200,48
891825	Electrov 24V Reductora Plásti 2 1/2"R	147,80	891846	Electrov 24VReductora Plásti 4"VIC	217,48
891830	Electrov 24V Reductora Plásti 3"R	178,05	891845	Electrov 24V Reductora Plásti 4"Brida	262,14



Electroválvulas NC reductora Latch (9V) plástico

Código	Artículo	€/Ud.	Código	Artículo	€/Ud.
890215	Electrov 9V Reductora Plásti 1 1/2"R	143,57	877255	Electrov 9V Reductora HE 5"Brida	332,70
890220	Electrov 9V Reductora Plásti 2"R	143,57	877265	Electrov 9V Reductora HE 6"Brida	663,56
890225	Electrov 9V Reductora Plásti 2 1/2"R	150,60	877285	Electrov 9V Reductora HE 8"Brida	1.254,43
890230	Electrov 9V Reductora Plásti 3"R	180,84	877238	Electrov 9V Reductora acodada 3" Brida	264,65



Válvula reductora plástico

Código	Artículo	€/Ud.	Código	Artículo	€/Ud.
890915	Válvula reductora Plásti 1 1/2"R	115,77	892820	Válvula reductora HE 2"R	128,37
890920	Válvula reductora Plásti 2"R	115,77	892825	Válvula reductora HE 2 1/2"R	138,85
890925	Válvula reductora Plásti 2 1/2"R	122,79	892830	Válvula reductora HE 3"R	154,54
890930	Válvula reductora Plásti 3"R	153,04	892840	Válvula reductora HE 4"R	266,46



Válvula sostenedora plástico

Código	Artículo	€/Ud.	Código	Artículo	€/Ud.
893315	Válvula Sostenedora Plásti 1 1/2"R	114,35	892885	Válvula reductora HE 8" Brida	1.226,31
893320	Válvula Sostenedora Plásti 2"R	114,35	892838	Válvula reductora acodada 3" Brida	237,64
893325	Válvula Sostenedora Plásti 2 1/2"R	121,38	892848	Válvula reductora acodada 4" Brida	318,75
893330	Válvula Sostenedora Plásti 3"R	151,62	892857	Válvula reductora acodada 5" Brida	321,92





Válvulas en Y de pistón plástico

Código	Artículo	€/Ud.
890050	Valvula en Y serie B 1 1/2" R Plast.	119,62
890063	Valvula en Y serie B 2" R Plast.	133,07
890090	Valvula en Y serie B 3" B/R Plast.	180,51
890100	Valvula en Y serie B 4" Brida Plast.	302,22
890150	Valvula en Y serie 6" Brida Plast.	665,30





Válvulas metal

Ris-Valves metálicas básicas rosca

Código	Artículo			€/Ud.
892310	Válvula básica 1"	-	20	41,15
891615	Vál. Serie HE 11/ 2"R	125	1	46,42
891620	Vál. Serie HE 2"R	125	1	47,22
891625	Vál. Serie HE 21/ 2"R	125	1	57,70
891630	Vál. Serie HE 3"R	90	1	73,39
891640	Vál. Serie HE 4"R	60	1	182,19





Ris-Valves metálicas básicas Victaulic

Código	Artículo			€/Ud.
892333	Válvula básica 3" victaulic	90	1	76,93
892343	Válvula básica 4" victaulic	60	1	139,98





Ris-Valves metálicas básicas Brida

Código	Artículo			€/Ud.
891635	Vál. Serie HE 3"Brida	45	1	122,43
891645	Vál. Serie HE 4"Brida	33	1	190,68
891655	Vál. Serie HE 5"Brida	22	1	221,11
891665	Vál. Serie HE 6"Brida	12	1	551,97
891685	Vál. Serie HE 8"Brida	1	1	1.143,79
891695	Vál. Serie HE 10"Brida	1	1	1.449,35
892412	Válvula básica 12" brida	1	1	3.014,09



Válvulas metálicas 90° básicas Brida

Código	Artículo			€/Ud.
891638	Válvula básica acodada 3" Brida	33	1	164,80
891648	Válvula básica acodada 4" Brida	22	1	246,46
891657	Válvula básica acodada 5" Brida	22	1	249,55



Válvulas metálicas con mando manual

Código	Artículo	€/Ud.
893115	Vál. + m.m Serie HE 11/ 2"R	70,20
893120	Vál + m m. Serie HE 2"R	71,00
893125	Vál. + m m Serie HE 21/ 2"R	81,48
893130	Vál. + m m Serie HE 3"R	97,17
893140	Vál. + m m Serie HE 4"R	206,59
893133	Vál + m m 3" vitaulic	100,71
893143	Vál + m m 4" vitaulic	164,37
893135	Vál. + m m Serie HE 3"Brida	146,21
893145	Vál. + m m Serie HE 4"Brida	215,07
893155	Vál. + m m Serie HE 5"Brida	245,50
893165	Vál. + m m Serie HE 6"Brida	576,36
893185	Vál. + m m Serie HE 8"Brida	1.168,18

Código	Artículo	€/Ud.
893137	Vál + m m acodada 3" Brida	180,271
893147	Vál + m m acodada 4" Brida	258,879
893157	Vál + m m acodada 5" Brida	262,045



Electroválvulas latch metálicas

Código	Artículo	€/Ud.
893415	Electroválvula latch HE 11/ 2"R	98,96
893420	Electroválvula latch HE 2"R	99,76
893425	Electroválvula latch HE 21/ 2"R	110,24
893430	Electroválvula latch HE 3"R	125,93
893440	Electroválvula latch HE 4"R	236,74
893433	Electrovalvula latch 3" vitaulic	129,47
893443	Electroválvula latch 4" vitaulic	194,52
893435	Electroválvula latch HE 3"Brida	174,97
893445	Electroválvula latch HE 4"Brida	245,22
893455	Electroválvula latch HE 5"Brida	275,65
893465	Electroválvula latch HE 6"Brida	606,51
893485	Electroválvula latch HE 8"Brida	1.197,43
893438	Electroválvula latch acodada 3" Brida	209,03
893448	Electroválvula latch acodada 4" Brida	289,03
893457	Electroválvula latch acodada 5" Brida	292,20



Electroválvulas 24 VAC metálicas

Código	Artículo	€/Ud.
878015	Electroválvula 24V HE 11/ 2"R	95,28
878020	Electroválvula 24V HE 2"R	96,08
878025	Electroválvula 24V HE 21/ 2"R	106,56
878030	Electroválvula 24V HE 3"R	122,25
878040	Electroválvula 24V HE 4"R	233,06
878033	Electrovalvula 24V 3" vitaulic	125,79
878043	Electroválvula 24V 4" vitaulic	190,84
878035	Electroválvula 24V HE 3"Brida	171,29
878045	Electroválvula 24V HE 4"Brida	241,54
878055	Electroválvula 24V HE 5"Brida	271,97
878065	Electroválvula 24V HE 6"Brida	602,83
878085	Electroválvula 24V HE 8"Brida	1.194,63
898038	Electroválvula 24V acodada 3" Brida	205,35
898048	Electroválvula 24V acodada 4" Brida	285,35
878057	Electroválvula 24V acodada 5" Brida	288,52



Electroválvulas 24 VAC Reductoras metálicas

Código	Artículo	€/Ud.
877015	Electrov 24V Reductora HE 11/ 2"R	150,90
877020	Electrov 24V Reductora HE 2"R	151,70
877025	Electrov 24V Reductora HE 21/ 2"R	162,18
877030	Electrov 24V Reductora HE 3"R	177,87
877040	Electrov 24V Reductora HE 4"R	290,11
877033	Electrov 24V Reductora 3" vitalic	181,41
877043	Electrov 24V Reductoar 4" vitalic	247,89
877035	Electrov 24V Reductora HE 3"Brida	226,91
877045	Electrov 24V Reductora HE 4"Brida	298,60
877055	Electrov 24V Reductora HE 5"Brida	329,02
877065	Electrov 24V Reductora HE 6"Brida	659,88
877085	Electrov 24V Reductora HE 8"Brida	1.251,64
877038	Electrov 24V Reductora acodada 3" Brida	260,97
877048	Electrov 24V Reductora acodada 4" Brida	342,40
877057	Electrov 24V Reductora acodada 5" Brida	345,57



Electroválvulas Latch (9V) Reductoras metálicas

Código	Artículo	€/Ud.
877215	Electrov 9V Reductora HE 11/ 2"R	154,58
877220	Electrov 9V Reductora HE 2"R	155,38
877225	Electrov 9V Reductora HE 21/ 2"R	165,86
877230	Electrov 9V Reductora HE 3"R	181,55
877240	Electrov 9V Reductora HE 4"R	293,79
877233	Electrov 9V Reductora 3" vitalic	185,09
877243	Electrov 9V Reductoar 4" vitalic	251,57
877235	Electrov 9V Reductora HE 3"Brida	230,59
877245	Electrov 9V Reductora HE 4"Brida	302,28
877255	Electrov 9V Reductora HE 5"Brida	332,70
877265	Electrov 9V Reductora HE 6"Brida	663,56
877285	Electrov 9V Reductora HE 8"Brida	1.254,43
877238	Electrov 9V Reductora acodada 3" Brida	264,65
877248	Electrov 9V Reductora acodada 4" Brida	346,08
877258	Electrov 9V Reductora acodada 5" Brida	349,25



Válvulas Reductoras metálicas

Código	Artículo	€/Ud.
892815	Válvula reductora HE 11/ 2"R	127,57
892820	Válvula reductora HE 2"R	128,37
892825	Válvula reductora HE 21/ 2"R	138,85
892830	Válvula reductora HE 3"R	154,54
892840	Válvula reductora HE 4"R	266,46
892833	Válvula reductora 3" vitaulic	158,09
892843	Válvula reductora 4" vitaulic	224,24
892835	Válvula reductora HE 3"Brida	203,58
892845	Válvula reductora HE 4"Brida	274,95
892855	Válvula reductora HE 5"Brida	305,37
892865	Válvula reductora HE 6"Brida	636,23
892885	Válvula reductora HE 8" Brida	1.226,31
892838	Válvula reductora acodada 3" Brida	237,64
892848	Válvula reductora acodada 4" Brida	318,75
892857	Válvula reductora acodada 5" Brida	321,92



Riego

RIS Valves

Contadores

Fertilización

Válvulas Sostenedoras metálicas

Código	Artículo	€/Ud.
893001	Válvula Sostenedora HE 11/ 2"R	126,07
893002	Válvula Sostenedora HE 2"R	126,87
892703	Válvula Sostenedora HE 21/ 2"R	137,35
892702	Válvula Sostenedora HE 3"R	153,04
893040	Válvula Sostenedora HE 4"R	265,30
893033	Válvula Sostenedora 3" vitaulic	156,58
893043	Válvula Sostenedora 4" vitaulic	223,08
893003	Válvula Sostenedora HE 3"Brida	202,08
893004	Válvula Sostenedora HE 4"Brida	273,78
893265	Válvula Sostenedora HE 5"Brida	304,21
893006	Válvula Sostenedora HE 6"Brida	635,07
893008	Válvula Sostenedora HE 8" Brida	1225,14
893037	Válvula Sostenedora acodada 3" Brida	236,14
893047	Válvula Sostenedora acodada 4" Brida	317,59
893057	Válvula Sostenedora acodada 5" Brida	320,75



Filtración

Programadores

Electroválvulas
IrritrolDifusores y
aspersoresComplementos
jardinería

Nebulización

Césped artificial

Todos los códigos de válvulas con pilotaje son para válvula normalmente cerrada, e incluyen:

- Fitting de tipo automático
- Solenoide de 3 vías RS100X - NO
- Piloto Plástico PN10 de 3 vías y 5.5 bar Máx. salida

Para otras configuraciones, como válvula normalmente abierta o solenoide y piloto de 2 vías entre otros, consultar diferentes posibilidades en el apartado de kits para válvulas hidráulicas.

Posibilidad de adaptar todos los modelos a conexión victaulic.

Válvulas contralavado serie B Plástico

Código	Artículo	€/Ud.
892750	Vál. B contralavado 2x2x2 Vic y Rosca. Plást	171,46
892764	Vál. B contralavado 3x3(2R)x3 Vict.Plást	220,95
892790	Vál. B contralavado 4x4x4 Vict.Plást	413,05



Repuestos membranas válvulas plástico

Código	Artículo	€/Ud.
704207	Memb. Vál 1 1/2", 2" y 2 1/2" RV Pls BP	13,05
704217	Membrana Vál 3" RV Pls BP	17,25
704219	Membrana Vál 4" RV Pls BP	17,46
704206	Memb.Vál 1 1/2", 2" y 2 1/2" RV Pls MP	13,05
704218	Memb.Vál 3" RV Pls MP	17,25
704220	Memb.Vál 4" RV Pls MP	17,46



Repuestos membranas válvulas metálicas

Código	Artículo	€/Ud.
704211	Memb. Vál 1 1/2", 2" y 2 1/2" RV Metal BP	11,14
704136	Membrana Vál 3" RV Metal BP	12,34
704144	Membrana Vál 4" y 5" RV Metal BP	29,76
704146	Membrana Vál 6" RV Metal BP	62,14
704170	Membrana Vál 8" RV Metal BP	92,90
704212	Memb. Vál 1 1/2", 2" y 2 1/2" RV Metal MP	11,14
704139	Membrana Vál 3" RV Metal MP	12,34
704145	Membrana Vál 4" y 5" RV Metal MP	29,76
704148	Membrana Vál 6" RV Metal MP	62,14
704171	Membrana Vál 8" RV Metal MP	92,90
704213	Memb. Vál 1 1/2", 2" y 2 1/2" RV Metal AP	11,14
704138	Membrana Vál 3" RV Metal AP	12,34
704142	Membrana Vál 4" y 5" RV Metal AP	29,76
704147	Membrana Vál 6" RV Metal AP	62,14
704172	Membrana Vál 8" RV Metal AP	92,90



Repuestos muelles válvulas metálicas

Código	Artículo	€/Ud.
704112	Muelle válvula 1 1/2", 2" y 2 1/2"	0,91
704113	Muelle válvula 3"	2,70
704114	Muelle válvula 4" y 5"	4,82
704038	Muelle válvula 6" (L90)	26,14
704167	Muelle válvula 8"	112,64



Soportes muelles válvulas hidráulicas

Código	Artículo	€/Ud.
765003	Soporte muelle válvulas hidráulicas 2" a 5"	3,12
765006	Soporte muelle válvula hidráulica 6"	9,25
765030	Soporte muelle válvulas hidráulicas 8" a 10"	34,64



Kits para válvulas

TIPOS FITTING



Plástico
PN 10



Metálico
PN 16



Automático
PN 16

Enchufe rápido de tubo - Sin necesidad de sellante en rosca

SOLENOIDES



RS100X
PN 10

RS1001 - 9V LATCH NO
RS 1002 - 24V AC NO y NC



S-392
PN 10

9V LATCH NO (392)

Con válvula 3 vías incorporada



GEM-SOL
PN 16

GEM-SOL - 24VAC NO
GEM-SOL - 24 VAC NC

PILOTOS



Plástico
PN 10/12



Metálico
PN 16

MICROTUBO



Poliamida

Díámetro [int x ext]

4x6mm 6x8mm
PN 27 PN 19

VÁLVULAS MANUALES



3 vías
PN 16



2 vías
PN 16

ACCESORIOS LECTURA PRESIÓN



Conexión aguja
manómetro



Manómetro
con aguja



Conexión
manómetro

Kit Mando Manual

Código	Tipo Fitting	Válv. 3 Vías	PN	Tipo Tubo (mm Int x mm Ext)	€/Ud.
493004	Automático	Sí	16	4x6	25,85
493000	Metálico	Sí	16	4x6	24,09
493005	Automático	Sí	16	6x8	26,51
493003	Metálico	Sí	16	6x8	25,10
493002	Plástico	Sí	10	6x8	18,86

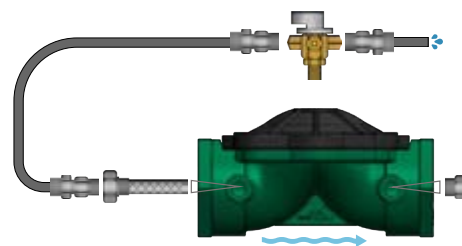

Kit Electroválvula Normalmente Cerrada con 3 Vías

Código	Tipo Fitting	PN	Tipo Solenoide	Tipo Tubo (mm Int x mm Ext)	€/Ud.
495009	Automático	10	9V Latch NO	4x6	56,03
495050	Metálico	10	9V Latch NO	4x6	52,55

494009	Automático	10	9V Latch NO	6x8	58,30
496042	Metálico	10	9V Latch NO	6x8	54,28
495056	Plástico	10	9V Latch NO	6x8	44,43

496004	Automático	10	24VAC NO	4x6	53,00
496023	Metálico	10	24VAC NO	4x6	49,51

496005	Automático	10	24VAC NO	6x8	55,26
496022	Metálico	10	24VAC NO	6x8	51,25
496021	Plástico	10	24VAC NO	6x8	41,39

495069	Automático	16	9V Latch NO	4x6	108,29
496051	Metálico	16	9V Latch NO	4x6	104,81

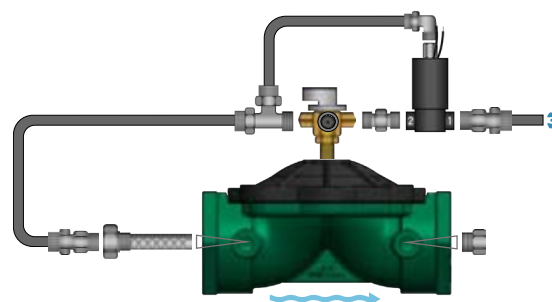

Código	Tipo Fitting	PN	Tipo Solenoide	Tipo Tubo (mm Int x mm Ext)	€/Ud.
495070	Automático	16	9V Latch NO	6x8	110,55
496052	Metálico	16	9V Latch NO	6x8	106,54

496030	Automático	16	24VAC NO	4x6	97,87
496048	Metálico	16	24VAC NO	4x6	94,39

496031	Automático	16	24VAC NO	6x8	100,13
496308	Metálico	16	24VAC NO	6x8	96,12

Kit Electroválvula Normalmente Cerrada sin 3 Vías

Código	Tipo Fitting	PN	Tipo Solenoide	Tipo Tubo (mm Int x mm Ext)	€/Ud.
495067	Automático	10	9V Latch NO	4x6	40,24
496309	Metálico	10	9V Latch NO	4x6	38,28

494006	Automático	10	9V Latch NO	6x8	41,21
496311	Metálico	10	9V Latch NO	6x8	39,18
496139	Plástico	10	9V Latch NO	6x8	33,00

495068	Automático	10	9V Latch NO (392)	6x8	67,16
496314	Metálico	10	9V Latch NO (392)	6x8	64,35
496317	Plástico	10	9V Latch NO (392)	6x8	58,76

495065	Automático	10	24VAC NO	4x6	37,20
496334	Metálico	10	24VAC NO	4x6	35,24

496410	Automático	10	24VAC NO	6x8	38,17
499014	Metálico	10	24VAC NO	6x8	36,14
499225	Plástico	10	24VAC NO	6x8	29,97

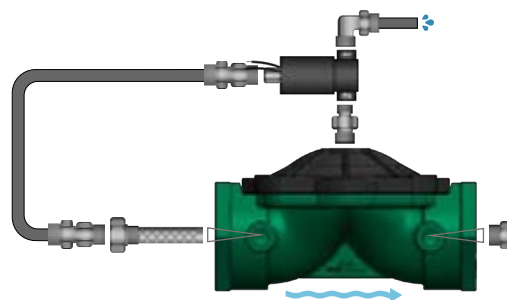

Código	Tipo Fitting	PN	Tipo Solenoide	Tipo Tubo (mm Int x mm Ext)	€/Ud.
495016	Automático	16	9V Latch NO	4x6	92,49
499017	Metálico	16	9V Latch NO	4x6	90,54

495018	Automático	16	9V Latch NO	6x8	93,46
499023	Metálico	16	9V Latch NO	6x8	91,44

495036	Automático	16	24VAC NO	4x6	82,07
499027	Metálico	16	24VAC NO	4x6	80,12

495038	Automático	16	24VAC NO	6x8	83,04
495039	Metálico	16	24VAC NO	6x8	81,01

Kit Electroválvula Normalmente Abierta con 3 Vías

Código	Tipo Fitting	PN	Tipo Solenoide	Tipo Tubo (mm Int x mm Ext)	€/Ud.
496006	Automático	10	24VAC NC	4x6	53,00
496043	Metálico	10	24VAC NC	4x6	49,51
496013	Automático	10	24VAC NC	6x8	55,26
496046	Metálico	10	24VAC NC	6x8	51,25
496047	Plástico	10	24VAC NC	6x8	41,39
496018	Automático	16	24VAC NC	4x6	97,87
496303	Metálico	16	24VAC NC	4x6	94,39
496019	Automático	16	24VAC NC	6x8	100,13
496307	Metálico	16	24VAC NC	6x8	96,12

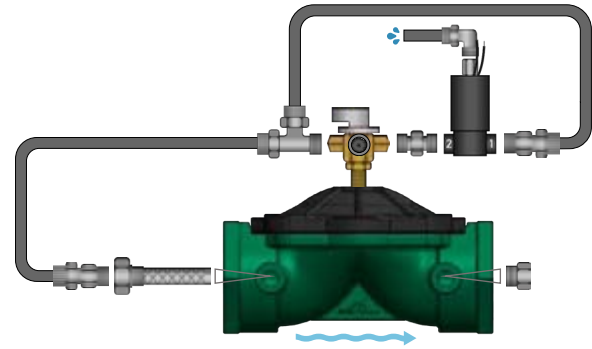

Kit Electroválvula Normalmente Abierta sin 3 Vías

Código	Tipo Fitting	PN	Tipo Solenoide	Tipo Tubo (mm Int x mm Ext)	€/Ud.
495071	Automático	10	24VAC NC	4x6	37,20
496318	Metálico	10	24VAC NC	4x6	35,24
495072	Automático	10	24VAC NC	6x8	38,17
496326	Metálico	10	24VAC NC	6x8	36,14
496330	Plástico	10	24VAC NC	6x8	29,97
495026	Automático	16	24VAC NC	4x6	82,07
499025	Metálico	16	24VAC NC	4x6	80,12
495028	Automático	16	24VAC NC	6x8	83,04
499026	Metálico	16	24VAC NC	6x8	81,01

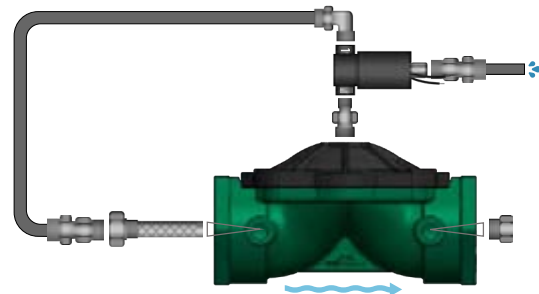

Kit Válvula Reguladora Piloto 3 Vías

Código	Tipo Fitting	PN	Tipo Piloto	Tipo Tubo (mm Int x mm Ext)	€/Ud.
496246	Automático	10	4 Bar	4x6	86,22
496304	Metálico	10	4 Bar	4x6	81,10
496248	Automático	10	4 Bar	6x8	89,69
496290	Metálico	10	4 Bar	6x8	83,62
496291	Plástico	10	4 Bar	6x8	70,81
496297	Automático	10	6 Bar	4x6	86,22
496306	Metálico	10	6 Bar	4x6	81,10
496298	Automático	10	6 Bar	6x8	89,69
496299	Metálico	10	6 Bar	6x8	83,62
496305	Plástico	10	6 Bar	6x8	70,81
496276	Automático	10	10 Bar	4x6	86,22
496310	Metálico	10	10 Bar	4x6	81,10
496278	Automático	10	10 Bar	6x8	89,69
496279	Metálico	10	10 Bar	6x8	83,62
496280	Plástico	10	10 Bar	6x8	70,81

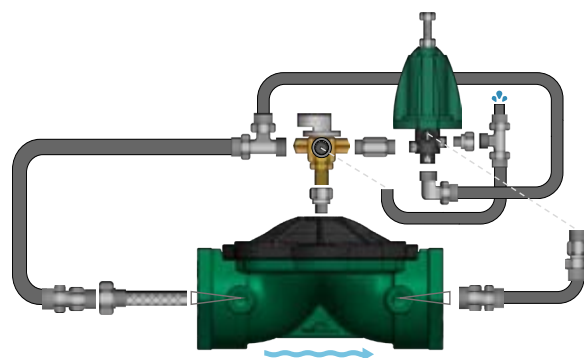

Código	Tipo Fitting	PN	Tipo Solenoide	Tipo Tubo (mm Int x mm Ext)	€/Ud.
496286	Automático	16	16 Bar	4x6	225,46
496287	Metálico	16	16 Bar	4x6	220,34
496288	Automático	16	16 Bar	6x8	228,93
496316	Metálico	16	16 Bar	6x8	222,86

Kit Válvula Reguladora Piloto 2 Vías

Código	Tipo Fitting	Tipo Piloto	PN	Tipo Tubo (mm Int x mm Ext)	€/Ud.
499260	Automático	2 Bar	10	4x6	89,83
499259	Metálico	2 Bar	10	4x6	87,31
499257	Automático	2 Bar	10	6x8	91,15
499256	Metálico	2 Bar	10	6x8	88,61
499255	Plástico	2 Bar	10	6x8	81,28
499254	Automático	8 Bar	10	4x6	87,95
499253	Metálico	8 Bar	10	4x6	85,43
493168	Automático	8 Bar	10	6x8	89,27
499251	Metálico	8 Bar	10	6x8	86,73
499250	Plástico	8 Bar	10	6x8	79,40

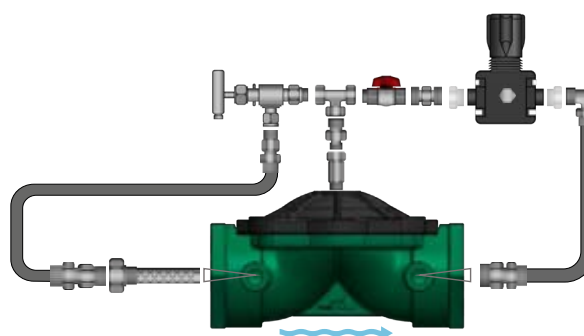

Código	Tipo Fitting	Tipo Piloto	PN	Tipo Tubo (mm Int x mm Ext)	€/Ud.
499249	Automático	16 Bar	16	4x6	108,24
499248	Metálico	16 Bar	16	4x6	105,60
493198	Automático	16 Bar	16	6x8	109,50
495216	Metálico	16 Bar	16	6x8	106,99

Kit Electroválvula Reguladora Piloto 3 Vías

Código	Tipo Fitting	Tipo Piloto	PN	Tipo Tubo (mm Int x mm Ext)	Tipo Solenoide	€/Ud.
498324	Automático	4 Bar	10	4x6	9V Latch NO	116,44
498303	Metálico	4 Bar	10	4x6	9V Latch NO	138,41
494348	Automático	4 Bar	10	6x8	9V Latch NO	120,26
494350	Metálico	4 Bar	10	6x8	9V Latch NO	113,25
494352	Plástico	4 Bar	10	6x8	9V Latch NO	97,90
498328	Automático	4 Bar	10	6x8	9V Latch NO (392)	148,67
498336	Automático	4 Bar	10	4x6	24VAC NC	115,23
498337	Metálico	4 Bar	10	4x6	24VAC NC	108,88
498338	Automático	4 Bar	10	6x8	24VAC NC	119,36
498355	Metálico	4 Bar	10	6x8	24VAC NC	111,77
498360	Plástico	4 Bar	10	6x8	24VAC NC	96,45
498339	Automático	4 Bar	10	4x6	24VAC NO	113,40
498304	Metálico	4 Bar	10	4x6	24VAC NO	107,11
498340	Automático	4 Bar	10	6x8	24VAC NO	117,22
498341	Metálico	4 Bar	10	6x8	24VAC NO	110,21
498311	Plástico	4 Bar	10	6x8	24VAC NO	94,86
498321	Automático	6 Bar	10	4x6	9V Latch NO	116,44
498291	Metálico	6 Bar	10	4x6	9V Latch NO	110,14
494368	Automático	6 Bar	10	6x8	9V Latch NO	120,26
498296	Metálico	6 Bar	10	6x8	9V Latch NO	113,25
498393	Plástico	6 Bar	10	6x8	9V Latch NO	97,90
498406	Automático	6 Bar	10	6x8	9V Latch NO (392)	148,67
498323	Automático	6 Bar	10	4x6	24VAC NC	115,23
498300	Metálico	6 Bar	10	4x6	24VAC NC	108,88
498330	Automático	6 Bar	10	6x8	24VAC NC	119,36
498293	Metálico	6 Bar	10	6x8	24VAC NC	111,77
498369	Plástico	6 Bar	10	6x8	24VAC NC	96,45
498302	Automático	6 Bar	10	4x6	24VAC NO	113,40
498306	Metálico	6 Bar	10	4x6	24VAC NO	107,11
498326	Automático	6 Bar	10	6x8	24VAC NO	117,22
498294	Metálico	6 Bar	10	6x8	24VAC NO	110,21
498305	Plástico	6 Bar	10	6x8	24VAC NO	94,86
498329	Automático	10 Bar	10	4x6	9V Latch NO	116,44
498307	Metálico	10 Bar	10	4x6	9V Latch NO	110,14

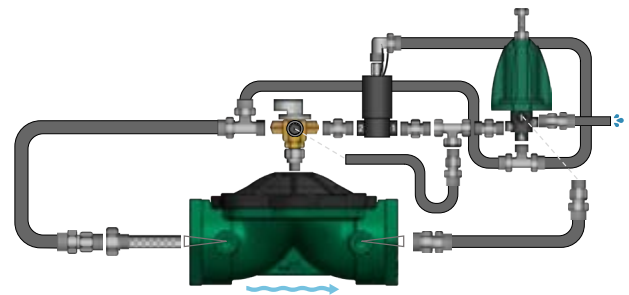

Código	Tipo Fitting	Tipo Piloto	PN	Tipo Tubo (mm Int x mm Ext)	Tipo Solenoide	€/Ud.
494398	Automático	10 Bar	10	6x8	9V Latch NO	120,26
498312	Metálico	10 Bar	10	6x8	9V Latch NO	113,25
498357	Plástico	10 Bar	10	6x8	9V Latch NO	97,90
498350	Automático	10 Bar	10	6x8	9V Latch NO (392)	148,67
498410	Automático	10 Bar	10	4x6	24VAC NC	115,23
498313	Metálico	10 Bar	10	4x6	24VAC NC	108,88
498352	Automático	10 Bar	10	6x8	24VAC NC	119,36
498314	Metálico	10 Bar	10	6x8	24VAC NC	111,77
498362	Plástico	10 Bar	10	6x8	24VAC NC	96,45
498309	Automático	10 Bar	10	4x6	24VAC NO	96,72
498317	Metálico	10 Bar	10	4x6	24VAC NO	107,11
498354	Automático	10 Bar	10	6x8	24VAC NO	117,22
498310	Metálico	10 Bar	10	6x8	24VAC NO	110,21
498353	Plástico	10 Bar	10	6x8	24VAC NO	94,86
498416	Automático	16 Bar	16	4x6	9V Latch NO	307,94
498315	Metálico	16 Bar	16	4x6	9V Latch NO	301,64
498418	Automático	16 Bar	16	6x8	9V Latch NO	311,76
498318	Metálico	16 Bar	16	6x8	9V Latch NO	304,75
498327	Automático	16 Bar	16	4x6	24VAC NC	299,35
498320	Metálico	16 Bar	16	4x6	24VAC NC	293,00
498332	Automático	16 Bar	16	6x8	24VAC NC	303,48
498328	Metálico	16 Bar	16	6x8	24VAC NC	148,67
498319	Automático	16 Bar	16	4x6	24VAC NO	297,52
498404	Metálico	16 Bar	16	4x6	24VAC NO	291,22
498334	Automático	16 Bar	16	6x8	24VAC NO	301,34
498316	Metálico	16 Bar	16	6x8	24VAC NO	294,33

Kit Electroválvula Reguladora Piloto 2 Vías

Código	Tipo Fitting	Tipo Piloto	PN	Tipo Tubo (mm Int x mm Ext)	Tipo Solenoide	€/Ud.
499233	Automático	2 Bar	10	4x6	9V Latch NC	136,11
499232	Metálico	2 Bar	10	4x6	9V Latch NC	133,59

499230	Automático	2 Bar	10	6x8	9V Latch NC	137,43
499229	Metálico	2 Bar	10	6x8	9V Latch NC	134,89
499227	Plástico	2 Bar	10	6x8	9V Latch NC	127,56

499399	Automático	2 Bar	10	4x6	24VAC NC	134,16
499398	Metálico	2 Bar	10	4x6	24VAC NC	131,64

499396	Automático	2 Bar	10	6x8	24VAC NC	135,48
--------	------------	-------	----	-----	----------	--------

499395	Metálico	2 Bar	10	6x8	24VAC NC	132,94
--------	----------	-------	----	-----	----------	--------

499394	Plástico	2 Bar	10	6x8	24VAC NC	125,61
--------	----------	-------	----	-----	----------	--------

499387	Automático	8 Bar	10	4x6	9V Latch NC	134,23
--------	------------	-------	----	-----	-------------	--------

499386	Metálico	8 Bar	10	4x6	9V Latch NC	131,71
--------	----------	-------	----	-----	-------------	--------

493682	Automático	8 Bar	10	6x8	9V Latch NC	135,55
--------	------------	-------	----	-----	-------------	--------

499384	Metálico	8 Bar	10	6x8	9V Latch NC	133,01
--------	----------	-------	----	-----	-------------	--------

499383	Plástico	8 Bar	10	6x8	9V Latch NC	125,68
--------	----------	-------	----	-----	-------------	--------

499382	Automático	8 Bar	10	4x6	24VAC NC	132,28
--------	------------	-------	----	-----	----------	--------

499381	Metálico	8 Bar	10	4x6	24VAC NC	129,76
--------	----------	-------	----	-----	----------	--------

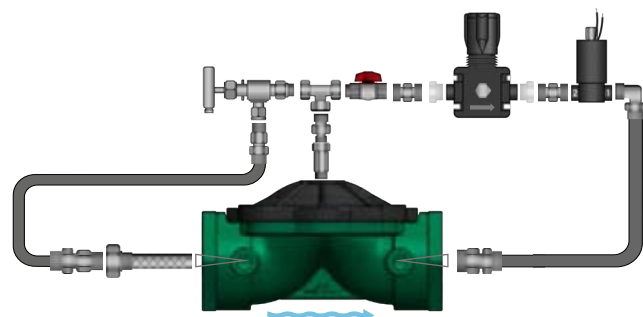

Código	Tipo Fitting	Tipo Piloto	PN	Tipo Tubo (mm Int x mm Ext)	Tipo Solenoide	€/Ud.
493086	Automático	8 Bar	10	6x8	24VAC NC	133,60
499379	Metálico	8 Bar	10	6x8	24VAC NC	131,06
499378	Plástico	8 Bar	10	6x8	24VAC NC	123,73

499372	Automático	16 Bar	16	4x6	9V Latch NC	112,21
499371	Metálico	16 Bar	16	4x6	9V Latch NC	109,71

493692	Automático	16 Bar	16	6x8	9V Latch NC	113,57
499370	Metálico	16 Bar	16	6x8	9V Latch NC	110,99

499369	Automático	16 Bar	16	4x6	24VAC NC	184,51
499368	Metálico	16 Bar	16	4x6	24VAC NC	182,01

493786	Automático	16 Bar	16	6x8	24VAC NC	202,92
499367	Metálico	16 Bar	16	6x8	24VAC NC	183,29

Kit Válvula Sostenedora Piloto 3 Vías

Código	Tipo Fitting	Tipo Piloto	PN	Tipo Tubo (mm Int x mm Ext)	€/Ud.
499009	Automático	4 Bar	10	4x6	84,68
499008	Metálico	4 Bar	10	4x6	79,96

499018	Automático	4 Bar	10	6x8	88,43
--------	------------	-------	----	-----	-------

499020	Metálico	4 Bar	10	6x8	82,44
--------	----------	-------	----	-----	-------

499021	Plástico	4 Bar	10	6x8	69,00
--------	----------	-------	----	-----	-------

499011	Automático	6 Bar	10	4x6	84,68
--------	------------	-------	----	-----	-------

499010	Metálico	6 Bar	10	4x6	79,96
--------	----------	-------	----	-----	-------

499028	Automático	6 Bar	10	6x8	88,43
--------	------------	-------	----	-----	-------

499029	Metálico	6 Bar	10	6x8	82,44
--------	----------	-------	----	-----	-------

499006	Plástico	6 Bar	10	6x8	69,00
--------	----------	-------	----	-----	-------

499013	Automático	10 Bar	10	4x6	84,68
--------	------------	--------	----	-----	-------

499031	Metálico	10 Bar	10	4x6	79,96
--------	----------	--------	----	-----	-------

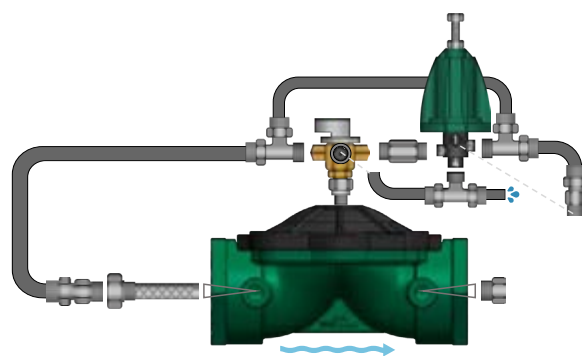

Código	Tipo Fitting	Tipo Piloto	PN	Tipo Tubo (mm Int x mm Ext)	€/Ud.
499048	Automático	10 Bar	10	6x8	88,43
499012	Metálico	10 Bar	10	6x8	82,44
499071	Plástico	10 Bar	10	6x8	69,00

499015	Automático	16 Bar	16	4x6	223,92
499065	Metálico	16 Bar	16	4x6	219,20

499058	Automático	16 Bar	16	6x8	227,67
499016	Metálico	16 Bar	16	6x8	221,69

Kit Electroválvula Sostenedora Piloto 3 Vías

Código	Tipo Fitting	Tipo Piloto	PN	Tipo Tubo (mm Int x mm Ext)	Tipo Solenoide	€/Ud.
499904	Automático	4 Bar	10	4x6	9V Latch NO	112,69
499299	Metálico	4 Bar	10	4x6	9V Latch NO	106,90

494548	Automático	4 Bar	10	6x8	9V Latch NO	117,42
499297	Metálico	4 Bar	10	6x8	9V Latch NO	109,89
499296	Plástico	4 Bar	10	6x8	9V Latch NO	94,07

499905	Automático	4 Bar	10	6x8	9V Latch NO (392)	146,38
--------	------------	-------	----	-----	-------------------	--------

499204	Automático	4 Bar	10	4x6	24VAC NC	107,19
499295	Metálico	4 Bar	10	4x6	24VAC NC	101,98

499218	Automático	4 Bar	10	6x8	24VAC NC	111,74
499293	Metálico	4 Bar	10	6x8	24VAC NC	104,69
499292	Plástico	4 Bar	10	6x8	24VAC NC	90,14

499226	Automático	4 Bar	10	4x6	24VAC NO	109,65
499291	Metálico	4 Bar	10	4x6	24VAC NO	103,86

499228	Automático	4 Bar	10	6x8	24VAC NO	114,38
499289	Metálico	4 Bar	10	6x8	24VAC NO	106,86
499288	Plástico	4 Bar	10	6x8	24VAC NO	91,03

499906	Automático	6 Bar	10	4x6	9V Latch NO	112,69
498301	Metálico	6 Bar	10	4x6	9V Latch NO	106,90

494568	Automático	6 Bar	10	6x8	9V Latch NO	117,42
499286	Metálico	6 Bar	10	6x8	9V Latch NO	109,89
499285	Plástico	6 Bar	10	6x8	9V Latch NO	94,07

499907	Automático	6 Bar	10	6x8	9V Latch NO (392)	146,38
--------	------------	-------	----	-----	-------------------	--------

499206	Automático	6 Bar	10	4x6	24VAC NC	107,19
499284	Metálico	6 Bar	10	4x6	24VAC NC	101,98

499208	Automático	6 Bar	10	6x8	24VAC NC	111,74
499282	Metálico	6 Bar	10	6x8	24VAC NC	104,69
499281	Plástico	6 Bar	10	6x8	24VAC NC	90,14

499207	Automático	6 Bar	10	4x6	24VAC NO	109,65
499280	Metálico	6 Bar	10	4x6	24VAC NO	103,86

499209	Automático	6 Bar	10	6x8	24VAC NO	114,38
498204	Metálico	6 Bar	10	6x8	24VAC NO	106,86
499278	Plástico	6 Bar	10	6x8	24VAC NO	91,03

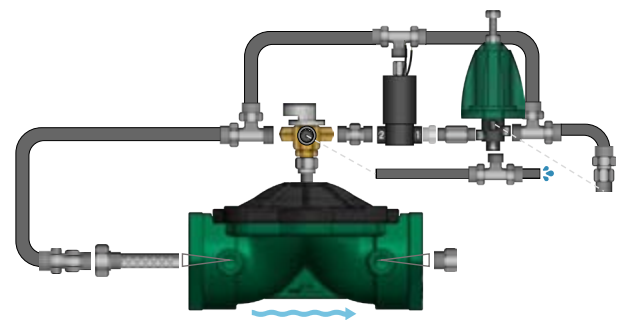

Código	Tipo Fitting	Tipo Piloto	PN	Tipo Tubo (mm Int x mm Ext)	Tipo Solenoide	€/Ud.
--------	--------------	-------------	----	-----------------------------	----------------	-------

499910	Automático	10 Bar	10	4x6	9V Latch NO	112,69
499277	Metálico	10 Bar	10	4x6	9V Latch NO	106,90

494598	Automático	10 Bar	10	6x8	9V Latch NO	117,42
499275	Metálico	10 Bar	10	6x8	9V Latch NO	109,89
499274	Plástico	10 Bar	10	6x8	9V Latch NO	94,07

499911	Automático	10 Bar	10	6x8	9V Latch NO (392)	146,38
--------	------------	--------	----	-----	-------------------	--------

499912	Automático	10 Bar	10	4x6	24VAC NC	107,19
499273	Metálico	10 Bar	10	4x6	24VAC NC	101,98

499913	Automático	10 Bar	10	6x8	24VAC NC	111,74
499271	Metálico	10 Bar	10	6x8	24VAC NC	104,69
499270	Plástico	10 Bar	10	6x8	24VAC NC	90,14

499914	Automático	10 Bar	10	4x6	24VAC NO	109,65
499269	Metálico	10 Bar	10	4x6	24VAC NO	103,86

499915	Automático	10 Bar	10	6x8	24VAC NO	114,38
498206	Metálico	10 Bar	10	6x8	24VAC NO	106,86
499267	Plástico	10 Bar	10	6x8	24VAC NO	91,03

499916	Automático	16 Bar	16	4x6	9V Latch NO	304,19
499266	Metálico	16 Bar	16	4x6	9V Latch NO	298,40

499918	Automático	16 Bar	16	6x8	9V Latch NO	308,92
499264	Metálico	16 Bar	16	6x8	9V Latch NO	301,39

499216	Automático	16 Bar	16	4x6	24VAC NC	291,30
499263	Metálico	16 Bar	16	4x6	24VAC NC	286,10

499219	Automático	16 Bar	16	6x8	24VAC NC	295,86
499262	Metálico	16 Bar	16	6x8	24VAC NC	288,80

499217	Automático	16 Bar	16	4x6	24VAC NO	293,77
499261	Metálico	16 Bar	16	4x6	24VAC NO	287,98

499221	Automático	16 Bar	16	6x8	24VAC NO	298,50
498216	Metálico	16 Bar	16	6x8	24VAC NO	290,97

Kit Válvula Reguladora y Sostenedora Piloto 3 Vías

Código	Tipo Fitting	Tipo Piloto	PN	Tipo Tubo (mm Int x mm Ext)	€/Ud.
496216	Automático	4 Bar	10	6x8	148,20
496346	Automático	6 Bar	10	6x8	148,20
496300	Automático	10 Bar	10	6x8	148,20
496301	Automático	16 Bar	16	6x8	426,58

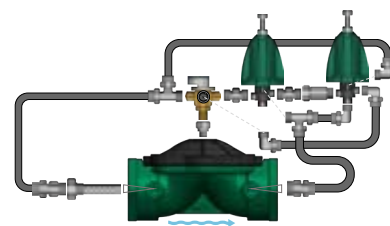

Kit flotador

Código	Artículo	€/Ud.
499130	Kit flotador depósito	91,20
499110	Kit flotador diferencial	493,53



Kit Toma Manómetro

Código	Artículo	€/Ud.
493010	Kit toma manómetro entrada.	9,33
493011	Kit toma manómetro salida	10,43



Kit Manómetro con Aguja

Código	Artículo	€/Ud.
493012	Manómetro con aguja	14,58



Kit Manómetro

Código	Artículo	€/Ud.
493016	Kit manómetro entrada. 10 Bar.	19,50
493017	Kit manómetro salida. 10 Bar.	20,73



Código	Artículo			€/Ud.
710949	Solen RS1001L 3W1/8" Latch NO	10	10	35,68
712448	Solen RS1002V 3W1/8"24VAC NO	10	10	31,15
712447	Solen RS1002V 3W1/8"24VAC NC	10	10	31,15
712449	Solen RS1002V 3W1/8"24VDC NO	10	10	31,15



Código	Artículo			€/Ud.
714899	Solen Bermad S-985 3W 3 Hilos Latch	100	20	136,24



712509	Solen Ris-Sol lacht 3w 2 hilos	100	20	32,48
496039	Kit Ris-Sol 9 V	1	1	56,00



713091	Solen Ris S-392 3W Latch	100	20	47,04
--------	--------------------------	-----	----	-------



Kits para electroválvula NC con otros solenoides RIS

Código	Tipo Fitting	PN	Tipo Solenoide	Tipo Tubo (mm Int x mm Ext)	€/Ud.
495064	Automático	10	9V Latch NO (S-392)	4x6	82,366
495086	Automático	10	9V Latch NO (S-392)	6x8	87,138
495063	Automático	10	9V Latch NO (RIS-SOL)	4x6	68,518

Código	Artículo			€/Ud.
714885	Geva 75 2 vías latch 9-12V DC	50	50	23,19
714712	Geva 75 2 vías 12 VDC	50	50	20,09
719937	Geva 75 3 vías 1,6 mm 24V AC N/C	25	25	36,71
719926	Geva 75 3 vías 1,6 mm 24V AC N/O	25	25	36,71
719949	Geva 75 3 vías 1,6 mm 12VDC N/O	25	25	36,71
719940	Geva 75 3 vías 1,6 mm latch 9-12V DC N/C	25	25	41,15
719941	Geva 75 3 vías 1,6 mm latch 9-12V DC N/O	25	25	41,15
719904	Solen G 75 A3P 3W 1/8 latch 2,6 mm	10	10	52,90
717316	Gemsol 3 vías 1,6 mm 24V AC N/C	30	30	60,24
717317	Gemsol 3 vías 1,6 mm 24V AC N/O	30	30	60,24
716316	Gemsol 3 vías 1,6 mm 12V DC N/C	30	30	60,24
716317	Gemsol 3 vías 1,6 mm 12V DC N/O	30	30	60,24
717341	Gemsol 3 vías 2 mm latch 9-12 V N/C	30	30	70,27
717340	Gemsol 3 vías 2 mm latch 9-12 V N/O	30	30	70,27
716111	Gemsol 3 vías 1,6 mm 110V AC N/C	30	30	60,24
716110	Gemsol 3 vías 1,6 mm 110V AC N/O	30	30	60,24
717319	Gemsol 3 vías 1,6 mm 24VDC N/O	30	30	58,49
294950	Conector solenoide Gemsol	1	1	3,46
719812	Solen. 3 W 1/8" Larga Distancia 12 VDC 1,6mm	20	1	199,53
719824	Solen. 3 W 1/8" Larga Distancia 24 VAC 1,6mm	20	1	199,53
719810	Solen. 3 W 1/8" Larga Distancia 12/24 VAC	50	1	128,27
294955	Petaca solenoide Gemsol LD	1	1	43,73
719970	Solen G 75 3 vías latch colector R	10	10	63,62
719977	Solen G 75 3 vías latch colector M	10	10	63,62
719974	Solen G 75 3 vías latch colector L	10	10	63,62
764071	Soporte colector Solen G 75	10	10	15,52

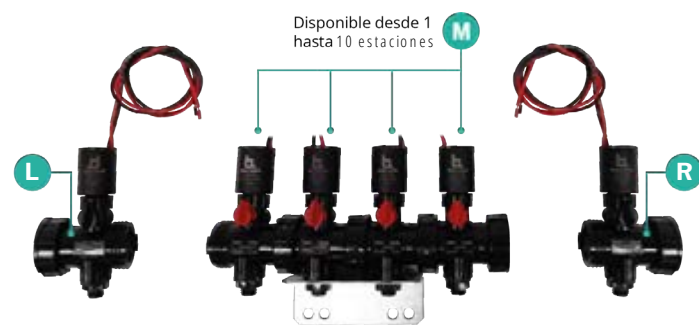

Kits para válvulas hidráulicas con solenoides Baccara



Kits para electroválvula NC con otros solenoides Baccara

Código	Tipo Fitting	PN	Tipo Solenoide	Tipo Tubo (mm Int x mm Ext)	€/Ud.
495061	Automático	10	9V Latch NO (G-75)	4x6	78,01
496029	Automático	10	24V-AC NO (G-75)	4x6	73,38
496038	Automático	16	12V-DC (GEM-SOL)	4x6	94,97

Kits para electroválvula reguladora con piloto plástico de 3 vías y solenoides Baccara

Código	Tipo Fitting	Tipo Piloto	PN	Tipo Tubo (mm Int x mm Ext)	Tipo Solenoide	€/Ud.
498295	Automático	4 Bar	10	4x6	24V-AC(GEM-SOL)	162,46
498298	Automático	6 Bar	10	4x6	24V-AC(GEM-SOL)	162,46
498299	Automático	4 Bar	10	4x6	9V Latch NO (G-75)	143,50
498303	Automático	6 Bar	10	4x6	9V Latch NO (G-75)	138,41

Accesorios para válvulas

Código	Artículo			€/Ud.
44032	Adaptador 2 hilos-3 hilos	1	1	22,22

701010	Rele hidráulico Galit	1	1	34,65
44071	Adaptador Galit	1	1	0,57
701001	Relé antipográfico 3 vías, con juego de muelles	1	1	59,52

620303	Piloto regulador 3 vías 10 bar XR 100	1	1	48,21
--------	---------------------------------------	---	---	-------

620403	Piloto R 3 vías PN 10 salida 0,2-3 Atm. Blanco	1	1	36,89
--------	--	---	---	-------

620406	Piloto R 3 vías PN 10 salida 1,5-5 Atm. Rojo	1	1	36,89
--------	--	---	---	-------

620409	Piloto R 3 vías PN 12 salida 1-9 Atm. Negro	1	1	36,89
--------	---	---	---	-------

704044	Repuesto muelle Blanco 0,2-3 Atm	1	1	6,52
--------	----------------------------------	---	---	------

704046	Repuesto muelle Rojo 1,5-5 Atm	1	1	6,52
--------	--------------------------------	---	---	------

704048	Repuesto muelle Negro 1-9 Atm	1	1	6,52
--------	-------------------------------	---	---	------

620332	Piloto regulador 3 vías inox 16 bar	1	1	256,44
--------	-------------------------------------	---	---	--------

620333	Piloto regulador 3 vías bronce 16 bar.	1	1	155,79
--------	--	---	---	--------

Código	Artículo			€/Ud.
429505	Filtro 1/4 con codo orientable 6x8 pl	100	100	4,79
429508	Filtro 1/4" válvula hidráulica	500	1	5,29

891961	Válvula 3W Plst. 1/4M 3 tomas 8 mm	1	1	8,89
--------	------------------------------------	---	---	------

891981	Válvula 3W Plst. 1/4Mx1/8Mx 2 tomas 8	1	1	8,89
--------	---------------------------------------	---	---	------

891918	Válvula 3 vías 1/4 x 1/8	80	1	9,00
--------	--------------------------	----	---	------

891920	Válvula 3 vías 1/8x1/8	50	25	9,00
--------	------------------------	----	----	------

891915	Válvula Sagiv 1/4 x 1/8	1	1	13,57
--------	-------------------------	---	---	-------

793008	Te selectora 6x8-1/8-6x8 pl	100	100	7,99
--------	-----------------------------	-----	-----	------

891900	Válvula 2 vías 6x8-1/4-6x8 pl	100	100	7,99
--------	-------------------------------	-----	-----	------

891906	Válvula 2 vías 6x8-1/4-1/8 pl	100	100	7,99
--------	-------------------------------	-----	-----	------

529462	Microtubo 4 x 6 mando hidráulico Poliamida	100	100	1,37
--------	--	-----	-----	------

529680	Microtubo 5,6 x 8 mando hidráulico Poliamida	100	100	1,62
--------	--	-----	-----	------

529681	Microtubo 6x8 Mando Hidráulico Campo	50	200	0,16
--------	--------------------------------------	----	-----	------

529684	Microtubo 5,5x8 Mando Hidráulico	20	800	0,16
--------	----------------------------------	----	-----	------

Fitting metálico

Código	Artículo			€/Ud.
704244	Recto macho 4x6 - 1/8	25	25	1,66
704248	Recto macho 4x6 - 1/4	25	25	1,63
704264	Recto macho 6x8 - 1/8	25	25	1,93
704268	Recto macho 6x8 - 1/4	25	25	2,07
704275	Recto macho 4x6 - M5	25	25	1,55

704344	Recto hembra 4x6 - 1/8	25	25	1,93
704348	Recto hembra 4x6 - 1/4	25	25	2,36
704364	Recto hembra 6x8 - 1/8	25	25	1,96
704368	Recto hembra 6x8 - 1/4	25	25	2,39

704446	Recto tubo-tubo 4x6	25	25	2,67
704468	Recto tubo-tubo 6x8	25	25	3,11

283044	Codo macho 4x6 - 1/8	25	25	2,26
283048	Codo macho 4x6 - 1/4	25	25	2,40
283064	Codo macho 6x8 - 1/8	25	25	2,43
283068	Codo macho 6x8 - 1/4	25	25	2,67

794004	Te tubo 4x6	25	25	3,99
794006	Te tubo 6x8	25	25	4,42
794044	Te macho 4x6 - 1/8 - 4x6	25	25	3,21
794064	Te macho 6x8 - 1/8 - 6x8	25	25	3,69
794144	Te macho lateral 4x6 - 4x6 - 1/8	25	25	3,33
794164	Te macho lateral 6x8 - 6x8 - 1/8	25	25	3,72
794168	Te macho lateral 6x8 - 6x8 - 1/4	25	25	3,94

560004	Machón 1/8	25	25	0,84
560008	Machón 1/4	25	25	1,23
560048	Machón reducido 1/8 - 1/4	25	25	1,23

Código	Artículo			€/Ud.
560144	Alargadera M-H 1/8 - 1/8. L=16 mm	25	25	2,51
560147	Alargadera M-H 1/4 - 1/4. L=19,4 mm	25	25	2,39
560145	Alargadera M-H 1/8 - 1/8. L=42 mm	25	25	2,51
560151	Alargadera M-H 1/4 - 1/4. L=51 mm	25	25	3,484

560148	Reducción M-H 1/8 - 1/4	25	25	1,36
560149	Reducción M-H M5-1/8	25	25	0,97

700614	Tuerca reducida M-H 1/4-1/8	25	25	1,36
400638	Tuerca reducida M-H 3/8-1/4	25	25	2,40
700612	Tuerca reducida M-H 1/2-1/4	25	25	1,80

390704	Manguito H 1/8-1/8	25	25	1,17
390708	Manguito H 1/8 - 1/4	25	25	1,60
390712	Manguito H 1/4 - 1/4	25	25	1,52

781844	Tapón macho 1/8	25	25	0,80
781848	Tapón macho 1/4	25	25	1,10

794204	Te hembra 1/8	25	25	2,52
794208	Te hembra 1/4	25	25	3,65

315004	Cruz hembra 1/8	25	25	4,554
315008	Cruz hembra 1/4	25	25	5,775

896004	Válvula esfera hembra 1/8 - 1/8	10	10	9,20
896008	Válvula esfera hembra 1/4 - 1/4	10	10	9,60

896140	Válvula esfera 1/8 M - 1/8 H	25	25	9,20
896148	Válvula esfera 1/4 M - 1/4 H	25	25	9,47

896138	Válvula esfera 3/8 M - 3/8 H	10	10	9,90
880018	Válvula aguja 1/8 M - 1/8 H	10	10	15,95

880014	Válvula aguja 1/4 M - 1/4 H	10	10	18,66
--------	-----------------------------	----	----	-------



Fitting plástico

Código	Artículo			€/Ud.
704241	Recto pl 1/8" x 6	100	100	0,86
704261	Recto pl 1/8" x 8	100	100	0,86
704265	Recto pl 1/4" x 8	100	100	0,86



283038	Codo pl 1/8" x 6	100	100	1,02
283043	Codo pl 1/8" x 8	100	100	1,02
283067	Codo pl 1/4" x 8	100	100	1,02



794076	Te pl 6x1/8"x6	100	100	1,12
794078	Te pl 8x1/8"x8	100	100	1,12
794080	Te pl 8x1/4"x8	100	100	1,12



283040	Codo orientable pl 1/8" x 6	100	100	1,50
283041	Codo orientable pl 1/8" x 8	100	100	1,50
283065	Codo orientable pl 1/4" x 8	100	100	1,50



Código	Artículo			€/Ud.
794005	Te igual pl 6x6x6	100	100	1,53
794007	Te igual pl 8x8x8	100	100	1,53
794141	Te pl 1/8" x6 x 6	100	100	1,15
794161	Te pl 1/8" x8 x 8	100	100	1,15
794167	Te pl 1/4"x8x8	100	100	1,15



794070	Te orientable pl 6 x 1/8" x 6	100	100	1,69
794065	Te orientable pl 8 x 1/8" x 8	100	100	1,69
794140	Te lateral orientable pl 1/8" x 6x6	100	100	1,69



704460	Unión pl 6x6	100	100	1,05
704480	Unión pl 8x8	100	100	1,05



560007	Machón pl 1/4"	100	100	1,05
--------	----------------	-----	-----	------



781842	Tapón pl 1/8	100	100	0,29
781845	Tapón pl 1/4"	100	100	0,35



Fitting automático

Código	Artículo			€/Ud.
700048	Racor recto 6 mm x 1/8"M	100	100	2,21
700049	Racor recto 6 mm x 1/4"M	100	100	2,35
700051	Racor recto 8 mm x 1/8"M	100	100	2,37
700054	Racor recto 8 mm x 1/4"M	100	100	2,55



294741	Conector recto 6 x 1/8" H	100	100	2,66
294744	Conector recto 6 x 1/4" H	100	100	3,06
294751	Conector recto 8 x 1/8" H	100	100	3,06
294754	Conector recto 8 x 1/4" H	100	100	3,35



700044	Racor recto tubo a tubo 6	100	100	2,59
700046	Racor recto tubo a tubo 8	100	100	2,91



Código	Artículo			€/Ud.
794441	Te orientable mixta 6-1/8"M-6	100	100	4,21
794451	Te orientable mixta 8-1/8"M-8	100	100	5,13
794541	Te orientable mixta 6-6-1/8"M	100	100	4,21
794544	Te orientable mixta 6-6-1/4"M	100	100	4,50
794551	Te orientable mixta 8-8-1/8"M	100	100	5,13
794554	Te orientable mixta 8-8-1/4"M	100	100	5,21



794554	Te orientable mixta 8-8-1/4"M	100	100	5,21
794644	Te tubo 6-6-6	100	100	3,90



283241	Codo orientable Rosca 6 x 1/8M	100	100	2,99
283244	Codo orientable Rosca 6 x 1/4M	100	100	3,26
283251	Codo orientable Rosca 8 x 1/8M	100	100	3,44
283254	Codo orientable Rosca 8 x 1/4M	100	100	3,62



283266	Codo tubo 6-6	100	100	2,757
283288	Codo tubo 8-8	100	100	3,210





Válvulas de bola y compuerta

Válvulas de PVC H-H encolar

Código	Artículo			€/Ud.
898120	Válvula bola 20	60	60	6,26
898125	Válvula bola 25	40	40	9,20
898132	Válvula bola 32	40	25	11,28
898140	Válvula bola 40	16	14	14,38
898150	Válvula bola 50	16	15	17,82
898163	Válvula bola 63	10	8	25,19
898175	Válvula bola 75	16	15	101,86
898190	Válvula bola 90	10	8	143,37



Válvulas de PVC H-H roscar

Código	Artículo			€/Ud.
898202	Válvula bola 1/2"	60	60	9,17
898204	Válvula bola 3/4"	40	40	9,73
898210	Válvula bola 1"	40	25	12,77
898214	Válvula bola 1 1/4"	16	14	15,07
898215	Válvula bola 1 1/2"	16	15	19,31
898220	Válvula bola 2"	10	8	26,91
898225	Válvula bola 2 1/2"	16	15	103,30



Válvulas de esfera metal H-H roscar

Código	Artículo			€/Ud.
897020	Válvula esfera 1/2"	54	8	5,52
897025	Válvula esfera 3/4"	42	8	7,41
897032	Válvula esfera 1"	40	8	11,91
897040	Válvula esfera 1 1/4"	16	6	19,69
897050	Válvula esfera 1 1/2"	8	2	27,18
897064	Válvula esfera 2"	12	2	40,31
897090	Válvula esfera 3"	6	4	132,76



Válvulas de compuerta Latón H-H roscar

Código	Artículo			€/Ud.
897120	Válvula compuerta 1/2"	48	16	7,38
897125	Válvula compuerta 3/4"	48	12	8,58
897132	Válvula compuerta 1"	32	8	11,83
897140	Válvula compuerta 1 1/4"	24	6	18,73
897150	Válvula compuerta 1 1/2"	12	4	24,59
897164	Válvula compuerta 2"	8	2	42,26



Válvulas de bola para tubo de polietileno

Código	Artículo			€/Ud.
898920	Válvula bola para tubo 20 x 20	150	10	3,742
898925	Válvula bola para tubo 25 x 25	96	6	4,703
898932	Válvula bola para tubo 32 x 32	60	5	6,420
898940	Válvula bola para tubo 40 x 40	40	4	11,932
898950	Válvula bola para tubo 50 x 50	32	4	16,239
898963	Válvula bola para tubo 63 x 63	16	2	20,866



Nuevo





Válvulas reductoras

Reductores de presión Plástico 3/4"

Código	Artículo			€/Ud.
700025	Regulador 3/4"M x 3/4"H.	125	10	7,55
700028	Regulador Hendrickson 3/4"M x 3/4" H	100	10	15,49
700101	Regulador Seninger 3/4"H x 3/4" H	50	10	20,48
700235	Regulador Seninger 1"H x1 1/4" H	50	10	42,67
701533	Regulador Seninger 1"H x1 1/4" H 25 PSI	50	10	42,67



Válvula reductora regulable metálica Redux

Código	Artículo			€/Ud.
702020	Reductor 1/2" H-H	30	40	38,60
702025	Reductor 3/4" H-H	30	40	59,41
702032	Reductor 1" H-H	15	20	72,13
702040	Reductor 1 1/4" H-H	6	20	147,19
702050	Reductor 1 1/2" H-H	6	20	157,14
702064	Reductor 2" H-H	3	20	251,88



Válvula de retención latón "RE-GE"

Código	Artículo			€/Ud.
892520	Válvula retención 1/2" H-H	120	30	5,17
892525	Válvula retención 3/4" H-H	90	24	7,27
892532	Válvula retención 1" H-H	48	12	10,74
892540	Válvula retención 1 1/4" H-H	24	10	15,32
892550	Válvula retención 1 1/2" H-H	16	5	21,34
892564	Válvula retención 2" H-H	8	2	36,50



Filtro válvula de retención

Código	Artículo			€/Ud.
429520	Filtro 1/2" M	224	30	0,88
429525	Filtro 3/4" M	152	15	1,15
429532	Filtro 1" M	80	15	1,71
429540	Filtro 1 1/4" M	36	10	1,94
429550	Filtro 1 1/2" M	24	10	2,66
429564	Filtro 2" M	16	5	3,33



Válvulas de Seguridad de escape conducido

Código	Artículo			€/Ud.
891012	Válvula de seguridad 3/8"	80	10	37,45
891016	Válvula de seguridad 1/2"	80	10	37,45
891025	Válvula de seguridad 3/4"	48	6	45,85
891032	Válvula de seguridad 1"	32	4	60,75
891040	Válvula de seguridad 1 1/4"	18	3	105,85
891050	Válvula de seguridad 1 1/2"	12	2	126,42
891064	Válvula de seguridad 2"	6	1	200,36



Válvulas de mariposa

Válvulas de Mariposa tipo Wafer PN 10

Código	Artículo			€/Ud.
899005	Válvula Mariposa DN 50	1	1	48,84
899006	Válvula Mariposa DN 65	1	1	58,06
899008	Válvula Mariposa DN 80	1	1	58,06
899010	Válvula Mariposa DN 100	1	1	82,14
899012	Válvula Mariposa DN 125	1	1	109,13
899015	Válvula Mariposa DN 150	1	1	126,56
899020	Válvula Mariposa DN 200	1	1	217,06
899025	Válvula Mariposa DN 250	1	1	305,84
899030	Válvula Mariposa DN 300	1	1	433,20



Válvulas motorizadas JJ

Código	Artículo			€/Ud.
899305	Válvula motorizada DN 50	1	1	570,53
899306	Válvula motorizada DN 65	1	1	735,24
899308	Válvula motorizada DN 80	1	1	875,72
899310	Válvula motorizada DN 100	1	1	946,57
899312	Válvula motorizada DN 125	1	1	1.238,54
899315	Válvula motorizada DN 150	1	1	1.491,00
899320	Válvula motorizada DN 200	1	1	1.881,31





Contadores

Contadores MJ plástico Chorro múltiple

Código	Artículo			€/Ud.
329020	Contador MJ Plast DN 20 mm 3/4"	10	1	64,61
329025	Contador MJ Plast DN 25 mm. 1"	3	1	97,49
329030	Contador MJ Plast DN 32 mm. 1 1/4"	5	1	107,42
329040	Contador MJ Plast DN 40 mm. 1 1/2"	4	1	172,73
408019	Emisor pulsos para M Jet Plastico	1	1	40,34



Contadores chorro múltiple RWS

Código	Artículo			€/Ud.
328020	Cont. chorro múltiple RWS DN 20 mm 3/4"	10	1	95,00
328025	Cont. chorro múltiple RWS DN 25 mm. 1"	3	1	113,36
328030	Cont. chorro múltiple RWS DN 30 mm. 1 1/4"	5	1	129,55
328040	Cont. chorro múltiple RWS DN 40 mm. 1 1/2"	4	1	221,31
328050	Cont. chorro múltiple RWS DN 50 mm. 2"	1	1	248,30
408018	Emisor de impulsos RWS	1	1	44,53



Contadores Woltman RWN

Código	Artículo			€/Ud.
325050	Contador Woltman RWN DN 50 mm 2"	1	1	321,98
325065	Contador Woltman RWN DN 65 mm 2 1/2"	1	1	353,90
325080	Contador Woltman RWN DN 80 mm 3"	1	1	430,88
325100	Contador Woltman RWN DN 100 mm 4"	1	1	463,02
325125	Contador Woltman RWN DN 125 mm 5"	1	1	554,18
325150	Contador Woltman RWN DN 150 mm 6"	1	1	771,15
325200	Contador Woltman RWN DN 200mm 8"	1	1	920,78
325250	Contador Woltman RWN DN 250mm 10 "	1	1	1.646,48
325300	Contador Woltman RWN DN 300mm 12"	1	1	3.186,56
323400	Contador Woltman RWN DN 400mm 16"	1	1	10.529,49
323500	Contador Woltman RWN DN 500mm 20"	1	1	14.187,11
408010	Emisor de impulsos RTW y RWN	1	1	45,72



Contadores de hélice tangencial RTWI

Código	Artículo			€/Ud.
327050	Contador RTWI DN 50 mm 2"	1	1	293,72
327065	Contador RTWI DN 65 mm 2 1/2"	1	1	332,51
327080	Contador RTWI DN 80 mm 3"	1	1	399,01
327100	Contador RTWI DN 100 mm 4"	1	1	432,26
327125	Contador RTWI DN 125 mm 5"	1	1	576,35
327150	Contador RTWI DN 150 mm 6"	1	1	653,94
327200	Contador RTWI DN 200mm 8"	1	1	886,69





Fertilización

Dosificadores Ventury

Inyectores ventury Mazzei

Código	Artículo	€/Ud.
370153	Dosificador Mazzei 1/2" PP	29,38
380025	Dosificador Mazzei 581-3/4" V PP	34,68
380032	Dosificador Mazzei 885X-1" VERDE PP	59,80
380050	Dosificador Mazzei 1 1/2" PP	74,24
380064	Dosificador Mazzei 2" PP	189,53

703806	Válv Antiretorno Mazey 2"	67,83
--------	---------------------------	-------

370204	Dosificador Mazzei 3/4" KYNAR	93,47
370285	Dosificador Mazzei 1" KYNAR	152,41
370452	Dosificador Mazzei 1 1/2" KYNAR	241,43
370506	Dosificador Mazzei 2" KYNAR	539,51
370608	Dosificador Mazzei 4" KYNAR	3.901,79



Kit Mazzei con válvula

Código	Artículo	€/Ud.
500416	Kit Mazzei 1/2" PP	41,91
500425	Kit Mazzei 3/4" PP	50,47
500432	Kit Mazzei 1" PP	79,46
500450	Kit Mazzei 1 1/2" PP	96,12
500525	Kit Mazzei 3/4" KYNAR	115,86
500532	Kit Mazzei 1" KYNAR	186,31
500550	Kit Mazzei 1 1/2" KYNAR	289,03



Kit Mazzei con caudalímetro y válvula

Código	Artículo	€/Ud.
500625	Kit Mazzei 3/4" PP con caudalímetro	105,43
500632	Kit Mazzei 1" PP con caudalímetro	138,56
500650	Kit Mazzei 1 1/2" PP con caudalímetro	155,23
500732	Kit Mazzei 1" KYNAR con caudalímetro	245,42
500750	Kit Mazzei 1 1/2" KYNAR con caudalímetro	348,13



Repuestos Mazzei

Código	Artículo	€/Ud.
500405	Kit aspiración mazey 1/2" y 3/4"	17,37
500410	Kit aspiración mazey 1" y 1 1/2"	22,65
703699	Filtro Mazey 2"	13,14
703925	Valv. Reguladora Mazzei 1/2" y 3/4"	49,92
703932	Valv. Reguladora Mazzei 1" y 1 1/2"	128,73
703701	Kit CR-2 Mazzei 1/2" y 3/4"	23,52
703704	Kit CR-4 Mazzei 1" y 1 1/2"	24,83



Otros dosificadores ventury

Código	Artículo			€/Ud.
370025	Dosificador 3/4" 3 mm con caudalímetro	10	1	33,97
370026	Dosificador 3/4" 6 mm con caudalímetro	10	1	33,97
370033	Dosificador 1" 10 mm con caudalímetro	10	1	33,97
703600	Repuesto filtro dosificador con caudalímetro	0	1	9,05



Bombas dosificadoras



Mixtron Bombas dosificadoras proporcionales

Código	Artículo	€/Ud.
382075	MX 075 P003V By-pass y on/off	463,51
382250	MX 250 P054V By-pass y on/off	485,05
382500	MX 500 P150V By-pass y on/off	1.072,81
382900	MX 900 P150 By-pass y on/off	1.572,13
300250	Kit junta MX 250	55,08
300500	Kit junta MX 500 y MX 900	155,11
300255	Kit filtro MX 250	81,67
300550	Kit filtro MX 500 y MX 900	86,42
500500	Kit muelle MX 500 y MX 900	26,59



Bombas dosificadoras electromagnéticas

Código	Artículo	€/Ud.
370262	Inyector Athena BX-2	320,76
370263	Inyector Athena PR-2	847,41
370264	Inyector Athena AM-2	433,12



Bombas dosificadoras eléctricas

Código	Artículo	€/Ud.
160172	Inyectora 170 L Inox. 220 V 10 Bar 1/2"H	1.101,63
160173	Inyectora 170 L Inox. 380 V 10 Bar 1/2" H	997,12
160222	Inyectora 220 L Inox. 220 V 8 Bar 1/2" H	1.417,57
160223	Inyectora 220 L Inox. 380 V 8 Bar 1/2" H	1.318,81
161181	Inyectora 118 L PVC 12VDC 8 Bar 1/2" H	1.651,01
162701	Inyectora 270 L PVC 12VDC 8 Bar 1/2" H	1.696,00



Complementos fertilización

Bombas soplantes

Código	Artículo	€/Ud.
169262	Bomba soplante UD, Discontinua 1,35 Kw	185,26
169270	Bomba soplante TF-0.55 Kw monof.	408,64
169281	Bomba soplante TF-1.5 KW monof.	841,13
169290	Bomba soplante TF-1.5 Kw Alum. Trifasica	733,79
169295	Bomba soplante TF-2,2 Kw Alum. Trifasica	827,32



Caudalímetros Rosca H 1/2"

Código	Artículo			€/Ud.
272212	Caudalímetro 1/2(20-120) l/h. policarbonato	100	1	49,75
272330	Caudalímetro 1/2(30-300) l/h. policarbonato	100	1	49,75
272550	Caudalímetro 1/2(50-500) l/h policarbonato	100	1	49,75
272615	Caudalímetro 3/4(150-1200) l/h. policarbonato	64	1	58,19
272704	Caudalímetro 1"(1000-4000) l/h. policarbonato	64	1	156,34
272710	Caudalímetro 1 1/2"(1000-9000) l/h policarbonato	64	1	200,75
272335	Caudalímetro 1/2(30-300) l/h polisulfona	100	1	145,47
272633	Caudalímetro 3/4(1000-3000) l/h polisulfona	64	1	164,87





Medidor PH y EC

Código	Artículo	€/Ud.
505762	Maletín con medidor de pH y EC	207,82
620150	Phmetro	63,73
299050	Conductímetro	63,73
740000	Sobre solución calibración pH	2,72
740001	Sobre solución calibración EC	2,72



Válvulas de abonado

Código	Artículo			€/Ud.
893901	Válvula 1/2" 24 VAC para abonado	20	10	135,77
891711	Válvula SF12 abonado 3/8" 24 VAC	12	10	253,11
893900	Válvula abonado amiad 3/4" NC	1	1	90,57



Tanques abonadores

Código	Artículo	€/Ud.
768060	Tanque abonador vertical 60 lts.	317,53
768100	Tanque abonador vertical 100 lts.	354,58
768200	Tanque abonador vertical 200 lts.	625,47





**Eficaz.
Seguro.
Robusto.**

Sistemas de filtrado de calidad y
servicios individualizados



Filtros metálicos manuales

Filtros cazapiedras

Código	Artículo			€/Ud.
419016	Filtro cazapiedras en Y 1/2" H	96	1	6,07
419025	Filtro cazapiedras en Y 3/4" H	48	1	8,87
419032	Filtro cazapiedras en Y 1" H	36	1	13,16
419040	Filtro cazapiedras en Y 1 1/4" H	16	1	24,74
419050	Filtro cazapiedras en Y 1 1/2" H	12	1	32,39
419064	Filtro cazapiedras en Y 2" H	9	1	56,11



Código	Artículo	€/Ud.
419065	Filtro cazapiedras en Y DN 50 2" B	79,22
419075	Filtro cazapiedras en Y DN 65 2 1/2" B	115,71
419090	Filtro cazapiedras en Y DN 80 3" B	134,69
419100	Filtro cazapiedras en Y DN 100 4" B	185,82
419125	Filtro cazapiedras en Y DN 125 5" B	255,62
419150	Filtro cazapiedras en Y DN 150 6" B	366,79
419200	Filtro cazapiedras en Y DN 200 8" B	626,09
419250	Filtro cazapiedras en Y DN 250 10" B	1.106,98
419300	Filtro cazapiedras en Y DN 300 12" B	1.599,01



Filtros metálicos de malla

Código	Artículo	€/Ud.
420852	Filtro de malla FMYR 2" R	299,38
420861	Filtro de malla FMYR 3" R	394,67
420701	Filtro de malla FMYR 3"	405,51
420702	Filtro de malla FMYR 4"	617,80
420885	Filtro de malla FMYR 5"	810,32
420897	Filtro de malla FMYR 6"	1.284,06
420899	Filtro de malla FMYR 8"	1.645,21



Filtros metálicos de discos

Código	Artículo	€/Ud.
420002	Filtro discos FDYR 2" R	359,85
420010	Filtro discos FD LR 3" R	425,28
420014	Filtro discos FDYR 3"	482,54
420016	Filtro discos FDYR 4"	1.088,78



Filtros metálicos de malla Aspersión

Código	Artículo	€/Ud.
420713	Filtro aspersión FMY 3"	367,83
420704	Filtro aspersión FMY 4"	544,39
420886	Filtro aspersión FMY 5"	716,47
420898	Filtro aspersión FMY 6"	974,40
420900	Filtro aspersión FMY 8"	1.346,97
420912	Filtro aspersión FMY 10"	1.954,53
421812	Filtro aspersión FMY 12"	2.862,39



Filtros metálicos de malla en L. Aspersión

Código	Artículo	€/Ud.
420714	Filtro aspersión en L 3"	353,12
420876	Filtro aspersión en L 4"	529,68
420887	Filtro aspersión en L 5"	687,81
420896	Filtro aspersión en L 6"	862,63
420901	Filtro aspersión en L 8"	1.275,32
420914	Filtro aspersión en L 10"	1.776,85
421512	Filtro aspersión en L 12"	2.782,14



Filtros centrifugadores

Código	Artículo	€/Ud.
420502	Filtro centrífugo FCYR 2"	383,75
420503	Filtro centrífugo FCYR 3"	490,71
420504	Filtro centrífugo FCYR 4"	561,05
420505	Filtro centrífugo FCYR 5"	964,65
420506	Filtro centrífugo FCYR 6"	1.458,52



Filtros semiautomáticos metal

Código	Artículo	€/Ud.
421042	Semiautomático 2"	613,72
421043	Semiautomático 3"	741,62
421044	Semiautomático 4"	999,21
421045	Semiautomático 5"	1.220,68
421046	Semiautomático 6"	1.994,31
421048	Semiautomático 8"	2.397,21



Hidrociclones

Código	Artículo	€/Ud.
420629	Hidrociclón HIDR 1" R	294,78
420630	Hidrociclón HIDR 1 1/2" R	358,34
420632	Hidrociclón HIDR 2" R	425,05
420640	Hidrociclón HIDR 2 1/2" B	576,76
421105	Hidrociclón HIDR 3" B	662,26
421109	Hidrociclón HIDR 4"	942,22
421116	Hidrociclón HIDR 5"	1.453,25
421118	Hidrociclón HIDR 6"	1.741,03



Filtros de Arena

Código	Artículo	€/Ud.
420286	Filtro arena FAR 1 1/2" R. 500 mm (125 Kg arena)	774,12
420313	Filtro arena FAR 2" R. 750 mm (350 Kg arena)	935,12
420353	Filtro arena FAR 3". 950 mm (600 Kg arena)	1.540,86
420402	Filtro arena FAR 4". 1200 mm. (1100 Kg arena)	2.400,63
420404	Filtro arena FAR 6". 1400 mm (1500 Kg arena)	3.489,29



Cabezales de filtrado de arena

Cabezales de filtrado de arena y malla con limpieza manual

Código	Artículo	€/Ud.
191112	1 FAR 1 1/2" + FMYR 2"	1.446,56
191213	1 FAR 2" + FMYR 2"	2.146,24
191313	1 FAR 3" + FMYR 3"	3.164,67
191414	1 FAR 4" + FMYR 4"	4.590,53
192214	2 FAR 2" + FMYR 4"	3.509,75
192314	2 FAR 3" + FMYR 4"	5.676,63
192416	2 FAR 4" + FMYR 6"	7.992,23
193316	3 FAR 3" + FMYR 6"	9.235,76
193418	3 FAR 4" + FMYR 8"	11.443,42
194444	4 FAR 4" + 4 FMYR 4"	15.729,75
196464	6 FAR 4" + 6 FMYR 4"	23.641,27



Cabezales de filtrado de arena y malla con limpieza automática

Código	Artículo	€/Ud.
192215	2 FAR 2" + FMYR 4" Aut.	5.103,08
192315	2 FAR 3" + FMYR 4" Aut.	7.921,07
192417	2 FAR 4" + FMYR 6" Aut.	10.898,22
193317	3 FAR 3" + FMYR 6" Aut.	11.396,14
193419	3 FAR 4" + FMYR 8" Aut.	15.880,67
194445	4 FAR 4" + 4 FMYR 4" Aut.	22.469,48
196465	6 FAR 4" + 6 FMYR 4" Aut.	34.348,74



Repuestos filtros metálicos

Código	Artículo	€/Ud.
200131	Cartucho FMYR 2	94,67
200157	Cartucho FMYR 3	129,24
200207	Cartucho FMYR 4	204,03
200208	Cartucho FMYR 5	301,19
200260	Cartucho FMYR 6	388,62
200280	Cartucho FMYR 8	446,89
200028	Cartucho FCYR 3	180,97
200029	Cartucho FCYR 4	235,37
200027	Cartucho FCYR 5	365,95



Código	Artículo	€/Ud.
490002	Junta Superior Filtro 2"	25,84
490003	Junta superior Filtro 3"	25,84
490004	Junta superior Filtro 4"	48,48
490005	Junta superior Filtro 5"	48,48
490006	Junta superior Filtro 6"	64,69
490008	Junta superior Filtro 8"	64,69
490021	Junta inferior Filtro 2"	25,84
490031	Junta inferior Filtro 3"	25,84
490274	Junta inferior Filtro 4"	48,48
490355	Junta inferior Filtro 5"	48,48
490365	Junta inferior Filtro 6"	64,69
490388	Junta inferior Filtro 8"	64,69



Filtros de plástico manuales

Filtros de malla RIS ONE

Código	Artículo		€/Ud.
428525*	Filtro RisOne 3/4"	60	6,36
428532*	Filtro Ris One 1"	60	6,36
428540*	Filtro Ris One 1 1/4"	25	10,66
428550*	Filtro Ris One 1 1/2"	25	10,66
428564*	Filtro Ris One 2"	13	20,73



204125*	Cartucho Malla 3/4" y 1"	6,55
204150*	Cartucho Malla 1 1/4"-1 1/2"	9,39
204164*	Cartucho Malla 2"	10,47



* Disponible hasta agotar existencias

Filtros de discos RIS ONE

Código	Artículo		€/Ud.
428725*	Filtro Discos RisOne D 3/4"	60	8,22
428732*	Filtro Discos Ris One D 1"	60	8,22
428740*	Filtro Discos Ris One D 1 1/4"	25	17,41
428750*	Filtro Discos Ris One D 1 1/2"	25	17,41
428764*	Filtro Discos Ris One D 2"	13	26,99



204325*	Cartucho Discos 3/4" y 1"	1	8,51
204350*	Cartucho Discos 1 1/4 - 1 1/2"	1	12,52
204364*	Cartucho Discos 2"	1	15,55



* Disponible hasta agotar existencias

Filtros de malla en Y Plástico

Código	Artículo	€/Ud.
428625	Filtro Y Malla 3/4"	4,98
428632	Filtro Y Malla 1"	4,98
428640	Filtro Y Malla 1 1/4"	10,80
428650	Filtro Y Malla 1 1/2"	10,80
428663	Filtro Y Malla 2"	15,78
428690	Filtro Y Malla 3"	33,60



200932	Cartucho malla 3/4" y 1"	3,29
200950	Cartucho malla 1 1/4" y 1 1/2"	11,53
200963	Cartucho malla 2"	12,36
200990	Cartucho malla 3"	28,83



Filtros de discos en Y Plástico

Código	Artículo	€/Ud.
428125	Filtro Y discos 3/4"	7,33
428132	Filtro Y discos 1"	7,33
428140	Filtro Y discos 1 1/4"	16,99
428150	Filtro Y discos 1 1/2"	16,99
428163	Filtro Y discos 2"	24,92
428190	Filtro Y discos 3"	44,40



200732	Cartucho discos 3/4" y 1"	4,53
200750	Cartucho discos 1 1/4" y 1 1/2"	14,83
200763	Cartucho discos 2"	20,59
200790	Cartucho discos 3"	37,07



Filtros de discos TORO F Series

Código	Artículo		€/Ud.
429432	Filtro F 25 1"	20	17,20
429440	Filtro F 32 1 1/4"	20	17,20
429450	Filtro F 40 1 1/2"	20	17,32
205500	Cartucho discos F 25, 32 y 40	1	13,67

Filtros de discos TORO SD

Código	Artículo	€/Ud.
429464	Filtro SD 2"	157,35
429495	Filtro SD 3" Corto	178,08
429490	Filtro SD 3"	217,12
205564	Cartucho anillas SD 2"	75,99
205590	Cartucho anillas SD 3"	113,19

Filtros de malla

Código	Artículo	€/Ud.
423564	RIS FILTERS T malla 2" Rosca	115,46
423590	RIS FILTERS T malla 3" Rosca	142,19
200289	Cartucho RIS FILTERS T malla 2"	42,55
200290	Cartucho RIS FILTERS T malla 3"	54,44

Filtros de discos

Código	Artículo	€/Ud.
424664	RIS FILTERS T disco 2" Rosca	124,38
424666	RIS FILTERS T disco 2" Super Rosca	162,73
424690	RIS FILTERS T disco 3" Rosca	167,73
424728	RIS FILTERS H disco 4" Victaulic	335,47
424729	RIS FILTERS H disco 4" Brida	436,85
205600	Cartucho RIS FILTERS T discos 2"	53,01
205602	Cartucho RIS FILTERS discos T3, 2S y H4 (2 uds)	60,33

Filtros semiautomaticos

Código	Artículo	€/Ud.
421025	RIS FILTERS malla semiautom 2" Vic y Brida	305,71
421035	RIS FILTERS malla semiautom 3" Vic y Brida	347,67
200307	Cartucho RIS FILTERS malla semiautom 2"	109,78
200308	Cartucho RIS FILTERS malla semiautom 3"	120,23



Hidrociclones Plástico

Código	Artículo	€/Ud.
420764	Hidrociclón RIS FILTERS 2"	335,45
420790	Hidrociclón RIS FILTERS 3"	387,06
420799	Hidrociclón RIS FILTERS 4"	423,23



Conexiones victaulic

Código	Artículo	€/Ud.
1114	Abrazadera victaulic 4" plástico	11,91
1102	Abrazadera victaulic 2" Metal	9,38
1103	Abrazadera victaulic 3" Metal	13,02
1104	Abrazadera victaulic 4" metal	19,95



41922	Adaptador 2" Vic a 2" R M Plást.	4,30
41933	Adaptador 3" Vic a 3" R M Plást.	8,15
178024	Adaptador 4" Vic a 4" Brida. Plást.	13,59



NOVO

42032	Adaptador victaulic 2 " a brida DN 50	32,70
42033	Adaptador victaulic 3 " a brida DN 80	37,68
42034	Adaptador victaulic 4 " a brida DN 100	52,37



42036	Adaptador victaulic 2 " a rosca 2"M	20,24
42038	Adaptador victaulic 3 " a rosca 3" M	35,07
42044	Adaptador victaulic 4 " a rosca 4" M	50,78



Filtros de plástico automáticos

Filtros automáticos de anillas

Código	Artículo	€/Ud.
425120	RIS FI LTERS T discos automático 2" Vic	504,38
425125	RIS FI LTERS T discos automático 2" Super Vic	543,66
425130	RIS FI LTERS T discos automático 3" Vic	548,39
425135	RIS FI LTERS H discos automático 3" Vic	993,48
425140	RIS FI LTERS H discos automático 4" Vic	1.081,50



Cabezales de filtrado de anillas 2" automáticos con programador 220 VAC

Código	Artículo	€/Ud.
212612	Cabezal anillas 1 x 2" 220 VAC	2.215,20
212622	Cabezal anillas 2x2" 220 VAC	3.610,00
212632	Cabezal anillas 3x2" 220 VAC	5.136,38
212642	Cabezal anillas 4x2" 220 VAC	6.451,05
212652	Cabezal anillas 5x2" 220 VAC	8.402,06
212662	Cabezal anillas 6x2" 220 VAC	10.131,90



Cabezales de filtrado de anillas 3" automáticos con programador 220 VAC

Código	Artículo	€/Ud.
212613	Cabezal anillas 1x3" 220 VAC	2.883,06
212623	Cabezal anillas 2x3" 220 VAC	3.892,96
212633	Cabezal anillas 3x3" 220 VAC	5.255,82
212643	Cabezal anillas 4x3" 220VAC	6.590,27
212653	Cabezal anillas 5x3" 220VAC	8.097,69
212663	Cabezal anillas 6x3" 220VAC	9.681,32



Cabezales de filtrado de anillas 2" automáticos con programador Latch 9 V

Código	Artículo	€/Ud.
212201	Cabezal anillas 1x2" Latch 9V	2.215,20
212202	Cabezal anillas 2x2" Latch 9V	3.610,00
212203	Cabezal anillas 3x2" Latch 9V	5.136,38
212204	Cabezal anillas 4x2" Latch 9V	6.451,05
212205	Cabezal anillas 5x2" Latch 9V	8.402,06
212206	Cabezal anillas 6x2" Latch 9V	9.776,39



Cabezales de filtrado de anillas 3" automáticos con programador Latch 9 V

Código	Artículo	€/Ud.
212301	Cabezal anillas 1x3" Latch 9V	2.883,06
212302	Cabezal anillas 2x3" Latch 9V	3.892,96
212303	Cabezal anillas 3x3" Latch 9V	5.255,82
212304	Cabezal anillas 4x3" Latch 9V	6.590,27
212305	Cabezal anillas 5x3" Latch 9V	8.097,69
212306	Cabezal anillas 6x3" Latch 9V	9.681,32



Cabezales gran capacidad 220 VAC

Código	Artículo	€/Ud.
212634	Cabezal 3x4" H 220 VAC	6.961,56
212644	Cabezal 4x4" H 220 VAC	10.297,88
212654	Cabezal 5x4" H 220 VAC	12.441,64
212664	Cabezal 6x4" H 220 VAC	15.078,82
212684	Cabezal 8x4" H 220 VAC	19.625,41



Riego

Ris Valves

Cabezales gran capacidad Latch 9 V

Código	Artículo	€/Ud.
212403	Cabezal 3x4" H Latch 9V	6.961,56
212404	Cabezal 4x4" H Latch 9V	10.297,88
212405	Cabezal 5x4" H Latch 9V	12.441,64
212406	Cabezal 6x4" H Latch 9V	15.078,82
212408	Cabezal 8x4" H Latch 9V	19.625,41



Contadores

Fertilización

Válvulas sostenedoras para poner en la salida de los equipos de filtrado

Código	Artículo	€/Ud.
893003	Válvula Sostenedora HE 3"Brida	202,08
893004	Válvula Sostenedora HE 4"Brida	273,78
893006	Válvula Sostenedora HE 6"Brida	635,07
893008	Válvula Sostenedora HE 8" Brida	1.225,14

Filtración

Programadores

Repuestos para filtros

Código	Artículo	€/Ud.
199502	Campana 2"	45,00
199503	Campana 3"	68,28

 Electroválvulas
Irritrol

130002	Base filtro T Manual 2"	42,42
130003	Base filtro T Manual 3"	53,80

 Difusores y
aspersores

130012	Base filtro T automático 2"	55,87
130013	Base Filtro T Automático 3"	86,90



1001	Abrazadera filtros Plástico	72,42
491001	Junta filtros plástico	14,66

 Complementos
jardinería

780022	Tapón Base 2"	12,41
780023	Tapón Base 3"	18,02

Nebulización

Césped artificial

Filtros automáticos de malla

Filtros de malla automáticos verticales sin equipar

Código	Artículo	€/Ud.
432064	Filtro Vertical. Auto.malla 2" Sin equipar	1.709,16
432096	Filtro Vertical. Auto.malla 3" Sin equipar	1.771,19
432128	Filtro Vertical. Auto.malla 4" Sin equipar	1.904,08



Filtros malla automáticos verticales, hidráulicos con programador a pilas 9V

Código	Artículo	€/Ud.
431064	Filtro Vertical. Auto.malla 2" Eléctrico 9 V	2.179,47
431096	Filtro Vertical. Auto.malla 3" Eléctrico 9 V	2.241,50
431128	Filtro Vertical. Auto.malla 4" Eléctrico 9 V	2.374,39



Filtros malla automáticos horizontales, hidráulicos con programador a pilas 9V

Código	Artículo	€/Ud.
433160	Filtro Horizontal. Auto malla 5 " Eléctrico 9 V	4.718,86
433192	Filtro Horizontal. Auto malla 6 " Eléctrico 9 V	4.382,67
433256	Filtro Horizontal. Auto malla 8 " Eléctrico 9 V	5.799,68
433320	Filtro Horizontal. Auto malla 10 " Eléctrico 9 V	8.042,30



Repuestos filtros automáticos de malla

Código	Artículo	€/Ud.
203102	Cartucho completo filtro Aut 2"	897,96
203103	Cartucho completo filtro Aut 3"	1.126,79
203104	Cartucho completo filtro Aut 4"	1.279,34
203516	Cartucho completo filtro Horiz Auto 6"	2.395,72
203518	Cartucho completo filtro Horiz. Auto 8"	3.276,35



505522	Malla con carcasa filtro Aut. 2"	377,91
505533	Malla con carcasa filtro Aut. 3"	516,59
505544	Malla con carcasa filtro Aut. 4"	634,47
505566	Malla con carcasa filtro Aut. 6"	1.213,46
505588	Malla con carcasa filtro Aut. 8"	1.854,87



199500	Campana completa filtro Auto Vertical	284,30
199501	Campana completa filtro Auto Horizontal	353,64



Programadores limpieza de filtros

Código	Artículo	€/Ud.
650424	Prog. Filtron 1-10 24 VAC	484,36
598124	Módulo ampliación filtron 2 Stn 24 VAC	60,70
650410	Prog. Filtron 1-10 a pilas	380,88
598110	Módulo ampliación filtron 2 Stn a pilas	60,70
735810	Presostato Filtron	97,50



650524	Prog. Risfilter 10 Stn AC	431,31
650509	Prog. Risfilter 10 Stn DC a pilas	425,78

498040	Kit automatismo 9V filtro Malla vertical	512,82
498060	Kit automatismo 9V filtro Malla Horizontal	562,52

649510	Presostato diferencial digital	231,22
--------	--------------------------------	--------





Atlas Programadores autónomos

SPHERAG

Atlas con cuota anual

Código	Artículo	€/Ud.
651432	Prog. Atlas 2 Stn Movistar. Conx. Transductor	378,60
651433	Prog. Atlas 2 Stn Vodafone. Conx. Transductor	378,60
651452	Prog. Solar Atlas 2 Stn. 2G Conx. Transductor	378,60
651422	Prog. Solar Atlas 2 Stn. contador datos cada 10 min	378,60
651504	Prog. Solar Atlas Plus 4 Stn	707,82
651508	Prog. Solar Atlas Plus 8 Stn	921,81



Cuotas a partir del segundo año

606252	Cuota anual conexión Atlas 2 S	25,00
606254	Cuota anual conexión Atlas 4 S	50,00
606258	Cuota anual conexión Atlas 8 S	60,00

Atlas sin cuota anual

Código	Artículo	€/Ud.
651472	Prog. Atlas 2 Stn Movistar. Conx. Transductor S/C	681,64
651473	Prog. Atlas 2 Stn Vodafone. Conx. Transductor S/C	681,64
651474	Prog. Atlas 2 Stn 2G. Conx. Transductor S/C	681,64
300600	Kit prog. Atlas 2 + Transductor de presión S/C	905,35
651404	Prog. Solar Atlas Plus 4 Stn S/C	1.201,65
651408	Prog. Solar Atlas Plus 8 Stn S/C	1.465,02



Complementos

Código	Artículo	€/Ud.
649512	Transductor de presión Atlas.	316,05
582571	Sensor nivel pozo hasta 10 mts.	832,92
582520	Sensor humedad de suelo Atlas. 10 mts. Máximo	408,23
750365	Sensor T° y Humedad atmosférica. Atlas.	408,23
294598	Conector para 4 sensores	115,23
701000	Rele Latch biestable	36,47



Programadores CICLON

CICLON 24 VAC

Código	Artículo	€/Ud.
653608	Ciclón 408 (220VAC-24VAC)	1.174,04
653616	Ciclón 416 (220VAC-24VAC)	1.239,79
653624	Ciclón 424 (220VAC-24VAC)	1.559,13
653632	Ciclón 432 (220VAC-24VAC)	1.953,61
653640	Ciclón 440 (220VAC-24VAC)	2.160,24
653648	Ciclón 448 (220VAC-24VAC)	2.385,65

CICLON 24 VDC

Código	Artículo	€/Ud.
653208	Ciclón 408 12 VDC	1.086,32
653216	Ciclón 416 12 VDC	1.155,26
653224	Ciclón 424 12 VDC	1.489,62
653232	Ciclón 432 12 VDC	1.944,21
653240	Ciclón 440 12 VDC	2.161,55
653248	Ciclón 448 12 VDC	2.385,65

Opciones programadores CICLON

Código	Artículo	€/Ud.
62106	Ampliación 6 entradas analógicas	540,33
606006	Opción control arranque diesel	97,26
606001	Opción ampliación 1 entrada demanda de riego	34,93
606050	Opción comunicación módulos extenos	129,68
606060	Opción empotrable	-
606040	Opción lectura sensores	194,52

Accesorios programador CICLON

Código	Artículo	€/Ud.
695000	Radio estación base maestro	368,33
870128	Unidad remota 12 v 8 estaciones panel solar	1.622,61
870228	Unidad remota 220 V 8 estaciones	1.418,36
799519	Transmisor pH y CE caja plástico	864,53
582803	Sensor pH con 3 mts. de cable, 7 Bar	542,12
582904	Sensor CE HI7635 con 4 mts cable, 5 Bar	326,90
582910	Sensor CE Burkett (directo en tubería)	646,23
582643	Sensor de presión 4-20 ma 0-10 BAR	172,91
798812	Trisensor Teros 12	1.069,85
606100	Transformador 24 VAC 100 VA	106,05
606110	Kit GPRS 2GT + Alojamiento en servidor	803,97
301020	KIT GPRS con detección corte eléctrico + Alojamiento servidor	1.111,65

Aplicación CICLON

Código	Artículo	€/Ud.
606200	Cuota anual App ciclón	166,26

Tempus Air Programadores

TORO.

THE TORO COMPANY

Sistema Tempus Air Lora y Bluetooth

Código	Artículo	€/Ud.
798492	Tempus Air RS 4 G Lora Gateway hasta 25 módulos	3.606,98
798393	Tempus Air BW wifi Lora Gateway hasta 30 módulos	490,86
798401	Tempus Air CT 1 Stn Lora y Bluetooth	415,59
798402	Tempus Air CT 2 Stn Lora y Bluetooth	490,86
798404	Tempus Air CT 4 Stn Lora y Bluetooth	575,55
798406	Tempus Air CT 6 Stn Lora y Bluetooth	652,39
798411	Tempus Air MS 1 entrada sensor. Lora y Bluetooth	304,24
798414	Tempus Air MS 4 entrada sensor. Lora y Bluetooth	448,52
582645	Tempus Air PS sensor presión. Lora y Bluetooth	744,92
891945	Tempus Air MV válvula maestra. Lora y Bluetooth	550,46
582511	Sensor de temperatura PT100	93,15
582540	Sensor de suelo VH400	228,97
582542	Sensor de suelo SM100	677,49
582544	Sensor viento ANEMO440 V3	373,24
649001	Pluviometro LEXCA001	219,56
582515	Sensor humedad HM1500LF	288,56
608020	Panel solar Tempus Air BS	508,11
608026	Panel solar Tempus Air BS soporte antiviento	762,17
700180	Rele arranque bomba Tempus Air CT	239,94
416410	Extensión 10 mts. Antena Tempus Air BW	388,93
606279	Suscripción anual Tempus Air BS	258,76
784279	SIM para Tempus Air suscripción anual	329,33



Sensórica
Metos

Riego

Ris Valves

Contadores

Fertilización

Filtración

Programadores

Electroválvulas
Irritrol

Difusores y
aspersores

Complementos
jardinería

Nebulización

Césped artificial

Gracias a la tecnología LoRa, Tempus® Air te permite crear un sistema de control completo y fiable para tu sistema de riego, de forma completamente inalámbrica

Sin cables.
Todos los módulos están alimentados por batería y cuentan con un grado de protección al agua IP68.

Programadores a pilas Irritrol

Tx8

Código	Artículo			€/Ud.
655900	Programador grifo Tx8	24	12	40,08



Tap Timer

Código	Artículo			€/Ud.
655950	Programador de grifo NewTap Timer	36	36	65,94



IT-ETT

Código	Artículo			€/Ud.
655940	Prog TT - ETT	6	6	76,39



Irritrol DC Bluetooth

Código	Artículo			€/Ud.
650301	Life DC 1 st	6	6	125,74
650302	Life DC 2 st	6	6	171,82
650304	Life DC 4 St	6	6	198,46
650306	Life DC 6 St	6	6	227,77



Irritrol DC Bluetooth con válvula 1"

Código	Artículo			€/Ud.
650310	Life DC 1 con válvula 2400 MT 1"	6	6	179,86



Solenoide Latch 9 V

Código	Artículo			€/Ud.
714888	Solenoide Irritrol latch DLC 2 vías	100	10	40,93
714880	Solenoide Ris latch 6-40 VDC 2 vías	100	10	30,58



Otros programadores a pilas

Programadores Baccara

Código	Artículo			€/Ud.
669809	Programador G75 con solen 9 V	1	1	98,04
665075	Programador G75 1 Stn sin solen	1	1	86,73
669812	Programador G75 2 Stn	1	1	116,93
669814	Programador G75 4 Stn	1	1	147,27



Programadores Solem

Código	Artículo			€/Ud.
650601	Programador Woobee DC 1	6	6	176,70
650602	Programador Woobee DC 2	6	6	276,04
650604	Programador Woobee DC 4	6	6	301,29
650606	Programador Woobee DC 6	6	6	340,06



Programadores a pilas Galcon DC 3 hilos

Código	Artículo			€/Ud.
654010	Galcon DC-1 con solen.	12	12	221,46
654040	Galcon DC-4 sin solen.	10	10	210,78
654025	Válv.700 3/4" con Galcon DC-1	1	1	242,09
654011	Válv.1" Bermad con Galcon DC-1	12	12	171,80
654032	Válv.2500-1" con Galcon DC-1	12	12	231,21
654050	Válv.R-216 1 1/2" con Galcon DC-1	1	1	230,77
654063	Válv.R-217 2" con Galcon DC-1	1	1	230,77
654190	Válv. CP 3" con Galcon DC-1	1	1	242,09
714700	Solenoide Galcon DC, 2 vías	5	5	50,74
496002	Kit reparación 2 vías	20	5	8,39



Programadores a pilas Galcon DC S

Código	Artículo			€/Ud.
654660	Galcon DC-6 S sin solen.	10	1	276,26
654120	Galcon DC-12 S	4	1	568,88



Programadores electrónicos Irritrol

LIFE y LIFE Plus Programadores

Código	Artículo			€/Ud.
650314	Life 4 stn	24	24	141,92
650316	Life 6 Stn	24	24	158,78
650318	Life 8 Stn	24	24	215,29
650350	Life Módulo programación	1	1	104,40
650354	Life base 4 Stn	1	1	43,42
650356	Life base 6 Stn	1	1	58,45
650358	Life base 8 Stn	1	1	99,06
350351	Life wifi modulo	1	1	138,06



Código	Artículo			€/Ud.
650404	Life Plus 4 stn	1	1	238,37
650364	Base Life Plus con transformador 220 V	1	1	144,59
598048	Módulo expansión 4 stn Life Plus	1	1	70,41



Rain Dial

Código	Artículo			€/Ud.
659315	Programador Rain Dial, 6 est.	6	6	338,96
659326	Programador Rain Dial, 9 est.	6	6	452,92
659337	Programador Rain Dial, 12 est.	6	6	565,32



704606	Módulo Rain Dial 6 stn.	5	1	186,96
704609	Módulo Rain Dial 9 stn.	5	1	261,44
704612	Módulo Rain Dial 12 stn.	5	1	331,36

Total Control

Código	Artículo			€/Ud.
653006	Programador Total Control 6 est.	6	6	479,73
653009	Programador Total Control 9 est.	6	6	546,47
653012	Programador Total Control 12 est.	6	6	674,40
653015	Programador Total Control 15 est.	6	6	769,48
653018	Programador Total Control 18 est.	6	6	842,77
653024	Programador Total Control 24 est.	6	6	1.080,03
653036	Programador Total Control 36 est.	6	6	2.964,00
653048	Programador Total Control 48 est.	6	6	3.403,11



Icod Plus

Código	Artículo			€/Ud.
330016	Codificador 16 stn. (expand. hasta 48)	1	1	1.449,67
598008	Módulo de expansión 8 stn.	1	1	157,90
340010	Decodificador Latch 1 st	1	1	198,50
340000	Decodificador para 1 stn.	1	1	198,50
340002	Decodificador para 2 Stn	1	1	332,34
340004	Decodificador para 4 Stn	1	1	633,10
340006	Decodificador para 6 Stn	1	1	888,75
340001	Decodificador para arranque de bomba	1	1	198,50
340003	Decodificador para válvula maestra	1	1	198,50



Mando a distancia para RD y TC

Código	Artículo			€/Ud.
652500	Mando a distancia RD y TC	1	1	177,21



Transformadores

Código	Artículo			€/Ud.
714901	Transformador 220 x 24 VAC, 20 VA	50	15	46,22
714905	Transformador 220 x 24 VAC, 30 VA	50	15	49,11
715046	Transformador interno Rain Dial	1	1	84,75

Relé de arranque de bomba

Código	Artículo			€/Ud.
701022	Relé de arranque PSR-22 Hasta 3,5 HP	10	1	177,50
701052	Relé de arranque PSR-53 Hasta 7,5 HP	10	1	502,06
701024	Rele 24 VAC (Carril DIN).	1	1	52,91



Electroválvulas Irritrol

Electroválvulas Irritrol 24 VAC

Epic

Código	Artículo			€/Ud.
894660	Epic 3/4"	18	18	20,32
894661	Epic 1"	18	18	20,46





Euro-M

Código	Artículo			€/Ud.
894674	Ecovalve Euro M 3/4" Macho	12	12	30,77
894678	Ecovalve Euro M 1" Macho	12	12	31,49





Euro-F

Código	Artículo			€/Ud.
894673	Ecovalve Euro F 3/4"	12	12	30,77
894677	Ecovalve Euro F 1"	12	12	31,49



Serie S

Código	Artículo			€/Ud.
893850	Válvula S-Series 1 1/2"	6	6	71,93
893864	Válvula S-Series 2"	6	6	121,91





2400 MT de Irritrol (Richdel)

Código	Artículo			€/Ud.
895506	Electroválvula 2400 MT 1" roscada	15	15	30,56
895497	Electroválvula 2400 MT 1" macho	10	10	30,56





2400 MTF de Irritrol (Richdel)

Código	Artículo			€/Ud.
895508	Electroválvula 2400 MTF 1" roscada	15	15	43,05





2500 MT de Irritrol (Richdel)

Código	Artículo			€/Ud.
895534	Electroválvula 2507 MT 3/4" con regulador	20	20	34,52
895510	Electroválvula 2500 MT 1" sin regulador	20	20	30,14



2500 MTF de Irritrol (Richdel)

Código	Artículo			€/Ud.
895511	Electroválvula 2500 MTF 1" con regulador	20	20	37,33



200-B de Irritrol (Richdel)

Código	Artículo			€/Ud.
895513	Electroválvula R-216 1 1/2"	10	10	96,80
895525	Electroválvula R-217 2"	10	10	134,02





Century Plus

Código	Artículo			€/Ud.
894501	Century Plus 1"	24	24	101,84
894502	Century Plus 1 1/2"	12	12	155,04
894555	Century Plus 2"	4	4	255,36
894607	Century Plus 3"	4	4	456,30



Ultraflow. Electroválvula de paso directo

Código	Artículo			€/Ud.
894625	Válvula Ultraflow HR 700 - 3/4"	24	24	40,74
894636	Válvula Ultraflow HR 700 1"	24	24	86,63
894644	Válvula Ultraflow HR 700 - 1 1/2"	12	12	133,35
894657	Válvula Ultraflow HR 700 - 2"	8	8	218,31



Electroválvulas Irritrol 9 V

Epic 9V

Código	Artículo			€/Ud.
895882	Epic 3/4" 9 V	18	18	48,27
895883	Epic 1" 9 V	18	18	48,41



Euro-R 9 V

Código	Artículo			€/Ud.
895803	Ecovalve Euro F 3/4" 9 V	12	12	58,72
895874	Ecovalve Euro M 3/4" Macho 9 V	12	12	58,72



Euro-F 9 V

Código	Artículo			€/Ud.
895801	Ecovalve Euro F 1" 9 V	12	12	59,44
895800	Ecovalve Euro M 1" Macho 9 V	12	12	59,44



Serie S 9 V

Código	Artículo			€/Ud.
895850	Válvula S-Series 1 1/2" 9 V	6	6	99,89
895864	Válvula S-Series 2" 9V	6	6	149,86



2400 MT 9 V

Código	Artículo			€/Ud.
895805	Electroválvula 2400 MT-M-9V	10	10	59,39
895806	Electroválvula 2400 MT -9 V	15	15	52,02
895808	Electroválvula 2400 MTF 9V	15	15	70,98



2500 MT 9V

Código	Artículo			€/Ud.
895834	Electroválvula 2507 MT 3/4" 9 V	20	20	62,53
895810	Electroválvula 2500 MT - 9V	20	20	58,19
895811	Electroválvula 2500 MTF - 9V	20	20	65,32



200-B 9 V

Código	Artículo			€/Ud.
895813	Electroválvula R-216 - 9 V 1 1/2"	10	10	124,24
895825	Electroválvula R-217- 9V 2"	10	10	161,11



Century Plus 9 V

Código	Artículo			€/Ud.
895827	Century Plus 1" 9V	24	24	130,17
895828	Century Plus 9V 1 1/2"	12	12	183,37
895832	Century Plus 9V 2"	4	4	283,69
895836	Century Plus 9V 3"	4	4	484,63



Ultraflow 9 V. Electroválvula de paso directo

Código	Artículo			€/Ud.
895802	Válvula Ultraflow HR 700 - 3/4" 9V	24	24	69,07
895841	Válvula Ultraflow HR 700 1" 9V	24	24	114,96
895842	Válvula Ultraflow HR 700 - 1 1/2" 9V	12	12	161,68
895843	Válvula Ultraflow HR 700 - 2" 9V	8	8	246,64



Regulador de presión Omni-Reg

Código	Artículo			€/Ud.
700100	Regulador de presión Omni-Reg	6	6	113,67



Electroválvula de baja presión

Código	Artículo			€/Ud.
894430	Válvula BP 1" 9V	24	24	64,09
894432	Válvula BP 1 1/4" 9V	24	24	70,87



Apertura desde 0,05 bar

Repuestos para electroválvulas

Código	Artículo			€/Ud.
714766	Solenoido 24 VAC, 6 VA	100	10	21,09
714888	Solenoido Irritrol latch DLC 2 vías	100	10	40,93
714880	Solenoido Ris latch 6-40 VDC 2 vías	100	10	30,58

714825	Kit portasolenoides válvulas Europeas	5	5	4,05
714850	Kit portasolenoides válvulas Americanas	5	5	4,83

704020	Diafragma Euro F y Euro M 3/4" y 1"	1	1	9,51
--------	-------------------------------------	---	---	------

704032	Kit diafragma R 2400	5	5	12,01
--------	----------------------	---	---	-------

704030	Kit diafragma R 2500	5	5	9,84
--------	----------------------	---	---	------

704050	Diafragma valvula R-216 1 1/2"	2	2	20,96
--------	--------------------------------	---	---	-------

704065	Diafragma valvula R-217 2"	2	2	24,82
--------	----------------------------	---	---	-------

704081	Tapa válvula 2400 MT - 1"	1	1	16,32
--------	---------------------------	---	---	-------

704083	Tapa válvula R-216 1 1/2"	1	1	53,76
--------	---------------------------	---	---	-------

704086	Tapa válvula R-217 2"	1	1	58,49
--------	-----------------------	---	---	-------

704001	Tuerca purgador válvula Richdel	20	1	6,75
--------	---------------------------------	----	---	------

Código	Artículo			€/Ud.
704023	Kit diafragma Century 1 1/2"	1	1	60,38
704025	Kit diafragma Century 2"	1	1	184,14
704028	Kit diafragma Century 3"	1	1	184,14

704010	Cruz reguladora válvula Richdel	1	1	3,83
--------	---------------------------------	---	---	------

704003	Eje válvula R-216 1 1/2" y R-217 2"	5	1	36,67
--------	-------------------------------------	---	---	-------

704092	Muelle válvula 2400 MT - 1"	1	1	0,90
--------	-----------------------------	---	---	------

704095	Muelle válvula R-216 1 1/2"	1	1	1,00
--------	-----------------------------	---	---	------

704097	Muelle válvula R-217 2"	1	1	1,65
--------	-------------------------	---	---	------

704150	Tapón válvula R-216 1 1/2"	1	1	15,24
--------	----------------------------	---	---	-------

704163	Tapón válvula R-217 2"	1	1	15,24
--------	------------------------	---	---	-------





Difusores Irritrol

Difusores I-Pro de Irritrol

Código	Artículo			€/Ud.
355007	Difusor I-PRO 300 7,5 cm	100	100	4,57
355010	Difusor I-PRO 400 10 cm	50	50	4,59
355015	Difusor I-PRO 600 15 cm	50	50	7,79
355030	Difusor I-PRO 1200 30 cm	25	25	14,93
892110	Válvula antidrenaje I-Pro	100	25	1,52
700026	Regulador Presión I-Pro	100	25	2,22

40040	Adaptador tobera	250	25	1,13
-------	------------------	-----	----	------

Toberas MPR de ángulo fijo de Irritrol

Código	Artículo			€/Ud.
103109	Tobera IPN 15 Q 90°	1000	25	2,11
103112	Tobera IPN 15 T 120°	1000	25	2,11
103118	Tobera IPN 15 H 180°	1000	25	2,11
103127	Tobera IPN 15 TQ 270°	1000	25	2,11
103136	Tobera IPN 15 F 360°	1000	25	2,11

Toberas MPR de riego en franja.

Código	Artículo			€/Ud.
103145	Tobera IPNSS Franja lateral (1,5x9m)	1000	25	2,10
103150	Tobera IPNCS Franja central (1,5x9 m)	1000	25	2,10
103155	Tobera IPNES Final franja (1,5 x 5 m)	1000	25	2,10

Toberas VAN, regulables de Irritrol



Código	Artículo			€/Ud.
103208	Tobera regulable 8 A, alcance 2,4 mts.	1000	25	2,45
103210	Tobera regulable 10 A, alcance 3,0 mts.	1000	25	2,45
103212	Tobera regulable 12 A, alcance 3,7 mts.	1000	25	2,45
103215	Tobera regulable 15 A, alcance 4,5 mts.	1000	25	2,45
103217	Tobera regulable 17 A, alcance 5,2 mts.	1000	25	2,45

Toberas inundación Irritrol

Código	Artículo			€/Ud.
102010	Toberas de inundación regulables	500	100	1,24



Difusores Slim line de Irritrol, con tobera regulable



Código	Artículo			€/Ud.
351200	Difusor SL-200, sin tobera	100	100	2,94
351210	Difusor SL-210 alcance 3,0 mts.	100	100	3,93
351212	Difusor SL-212 alcance 3,7 mts.	100	100	3,93
351215	Difusor SL-215 alcance 4,5 mts.	100	100	3,93
351217	Difusor SL-217 alcance 5,2 mts.	100	100	3,93
351400	Difusor SL-400, sin tobera	50	50	3,35
351410	Difusor SL-410 alcance 3,0 mts.	50	50	4,19
351412	Difusor SL-412 alcance 3,7 mts.	50	50	4,19
351415	Difusor SL-415 alcance 4,5 mts.	50	50	4,19
351417	Difusor SL-417 alcance 5,2 mts.	50	50	4,19
351600	Difusor SL-600, sin tobera	50	50	9,94
351610	Difusor SL-610 alcance 3,0 mts.	50	50	13,32
351612	Difusor SL-612 alcance 3,7 mts.	50	50	13,32
351615	Difusor SL-615 alcance 4,5 mts.	50	50	13,32
351617	Difusor SL-617 alcance 5,2 mts.	50	50	13,32
892100	Check valve SL	100	25	2,72



Aspersores Irritrol





Aspersor R 430

Código	Artículo			€/Ud.
115643	Asp Irritrol R 430 1/2"	25	25	17,66



Aspersor R 550

Código	Artículo			€/Ud.
115655	Asp Irritrol R 550 3/4"	20	20	21,29
892148	Check valve para R 550	20	20	3,16
501255	Llave para R550	20	20	6,60



Aspersor Platinum

Código	Artículo			€/Ud.
115800	Asp Platinum 1" plast.	10	10	69,36
115802	Asp Platinum 1" Inox.	10	10	129,75



Aspersor Titán

Código	Artículo			€/Ud.
115261	Asp.Irritrol Titán (incluye 5 toberas)	20	20	25,87



Cañones de riego

Aspersor Perrot - Irritrol

Código	Artículo			€/Ud.
115510	Asp SGS 105 1 1/2" con válvula	1	1	713,34
115517	Asp SPS 178 2" con válvula	1	1	3.601,44



Sportgun

Código	Artículo			€/Ud.
115700	Aspersor Sportgun 1 1/2"	2	2	719,01
775700	Tapa cesped Sportgun	2	2	118,52





Playground. Cañón emergente 2"

Código	Artículo			€/Ud.
115702	Aspersor Playground 2 "	2	2	1.164,12
501120	Llave aspersor playground	1	1	95,38





Playground con electroválvula

Código	Artículo			€/Ud.
115701	Asp. ST1700V 2" con válvula	2	2	3.269,80





Royal. Toberas 14,16,18,20 y 22

Código	Artículo			€/Ud.
293012	Cañón Royal 2"	1	1	1.129,88





Reflex. Toberas 22,24,26,28 y 30

Código	Artículo			€/Ud.
293013	Cañón Reflex 3"	1	1	1.497,94



Adaptadores cañones

Código	Artículo			€/Ud.
178302	Brida galvanizado 2" a rosca 2"H	1	1	24,27
562064	Machón metálico 2" x 2"	1	1	9,98
178303	Brida galvanizado 3" a rosca 3"H	1	1	50,23
565975	Machón Galvan. Reducido 3"-2"	1	1	37,24



Difusores Hunter





Difusores PSU

Código	Artículo			€/Ud.
352010	Difusor PSU 02 10A, alcance 3,0 m.	100	100	4,49
352012	Difusor PSU 02 12A, alcance 3,7 m.	100	100	4,49
352015	Difusor PSU 02 15A, alcance 4,6 m.	100	100	4,49
352017	Difusor PSU 02 17A, alcance 5,2 m.	100	100	4,49
352055	Difusor PSU 02 5SS, alcance 1,5x9 m.	100	100	4,94
354010	Difusor PSU 04 10A, alcance 3,0 m.	100	100	4,49
354012	Difusor PSU 04 12A, alcance 3,7 m.	100	100	4,49
354015	Difusor PSU 04 15A, alcance 4,6 m.	100	100	4,49
354017	Difusor PSU 04 17A, alcance 5,2 m.	100	100	4,49
354055	Difusor PSU 04 5SS, alcance 1,5x9 m.	100	100	4,94
892135	Check valve para PSU, hasta 2,1 mca	100	25	1,47





MP 1000. Radio 2,5 a 4,6 mts.

Código	Artículo			€/Ud.
586211	MP 1000 90 - 210°	10	10	16,02
586271	MP 1000 210 - 270°	10	10	16,02
586361	MP 1000 360°	10	10	16,02



MP 2000. Radio 4,9 a 6,4 mts.

Código	Artículo			€/Ud.
586212	MP 2000 90 - 210°	10	10	16,02
586272	MP 2000 210 - 270°	10	10	16,02
586362	MP 2000 360°	10	10	16,02





MP 3000. Radio 7,9 a 9,1 mts.

Código	Artículo			€/Ud.
586213	MP 3000 90 - 210°	10	10	16,02
586273	MP 3000 210 - 270°	10	10	16,02
586363	MP 3000 360°	10	10	16,02





MP Franja



Código	Artículo			€/Ud.
586101	MP Corner 45 - 105°	10	10	16,02
586071	MP-SS Franja Lateral	10	10	16,02
586081	MP-LS Franja Izquierda	10	10	16,02
586091	MP-RS Franja Derecha	10	10	16,02
505800	MPR llave de ajuste	10	10	1,54



SRM 1/2"

Código	Artículo			€/Ud.
115074	Aspersor Hunter SRM-04ADJ	25	25	18,09
892139	Válvula antidrenaje SRM	25	25	1,47
501150	Llave aspersor y difusor Hunter	100	5	0,73



PGJ 1/2"

Código	Artículo			€/Ud.
115060	Aspersor Hunter PGJ-04	25	25	18,49

PGP ADJ 3/4"

Código	Artículo			€/Ud.
115004	Aspersor PGP-ADJ 10 cm	20	20	21,61

PGP Ultra 3/4"

Código	Artículo			€/Ud.
115015	Aspersor PGP-00 Ultra aéreo	20	20	24,07
115020	Aspersor PGP-04 Ultra 10 cm	20	20	21,13
115022	Aspersor PGP-12 Ultra 30 cm	12	12	68,75
892146	Válvula antidrenaje serie PG	100	25	1,47
892175	Válvula antidrenaje HCV 3/4"M-H	1	1	13,95

I-25 Ultra 1"

Código	Artículo			€/Ud.
115102	Aspersor Hunter I25-04 Ultra Plástico	12	12	93,75
115104	Aspersor Hunter I25-04-SS Ultra Metál	12	12	122,72



I-40 Ultra 1"

Código	Artículo			€/Ud.
115080	Aspersor Hunter I40-04-SS Ultra metál	12	12	185,79
495048	Cazoleta cespced para I-40	1	1	70,75

I-90 11/2"



Código	Artículo			€/Ud.
115191	Aspersor I-90 36 V 360°	6	6	345,86
115190	Aspersor I-90 ADV, arco ajustable	6	6	345,86
495049	Cazoleta cespced para I-90	1	1	98,67

G-800 11/2"

Código	Artículo			€/Ud.
114987	G880 C Circular	4	4	501,51
114989	G880 E Circular con válvula	4	4	566,35
114975	G885 C Sectorial	4	4	553,38
114977	G885 E Sectorial con válvula	4	4	618,24
40016	Adaptador rosca 11/2" x 11/2" G 800	1	1	13,58





G-900 11/2"

Código	Artículo			€/Ud.
114991	G990 C Circular	4	4	533,21
114990	G990 E Circular con válvula	4	4	621,11
114996	G995 Sectorial	4	4	586,54
114995	G995 E sectorial con válvula	4	4	674,43
40014	Adaptador rosca 11/2" x 11/2" G 900	1	1	13,58



Aspersores aéreos

Aspersor Green Lawn plástico 1/2"

Código	Artículo			€/Ud.
113006	Asp. Green Lawn, plastico II	200	50	3,82



Aspersor Green Lawn metal 1/2"

Código	Artículo			€/Ud.
113010	Asp, Green Lawn, metal	80	20	18,91



Aspersores 1/2" de latón

Código	Artículo			€/Ud.
113020	Asp. AQ 05 PC 1/2"	25	1	18,85
112025	Asp. NR 19 1/2"	100	1	28,17



Aspersores 3/4" de latón

Código	Artículo			€/Ud.
113025	Asp. AQ 20 PC 3/4"	20	1	33,02
112006	Asp. NR 26 3/4"	40	1	34,82





Aspersores 1" de latón

Código	Artículo			€/Ud.
113030	Asp. AQ 30PC 1"	10	1	66,87
111836	Asp. NR 38 1"	20	1	85,79



Trineos para aspersores

Código	Artículo			€/Ud.
799012	Trineo 1/2" h 33 cm	0	5	91,62
799034	Trineo 3/4" h 33 cm	0	5	97,78
799046	Trineo 1" h 60 cm	0	5	105,02





Complementos jardinería

Sensores de lluvia

Código	Artículo			€/Ud.
582605	Sensor RS 500	20	1	42,55
582610	Sensor RFS1000	20	1	147,83
582510	Climate Logic System	1	1	278,10



Cable eléctrico antihumedad

Código	Artículo			€/Ud.
549021	Cable 2 x 1	100	100	Consultar
549031	Cable 3 x 1	100	100	Consultar
549051	Cable 5 x 1	100	100	Consultar
549071	Cable 7 x 1	100	100	Consultar
549101	Cable 10 x 1	100	100	Consultar
549131	Cable 12 x 1	100	100	Consultar
549012	Cable 1 x 1,5	100	100	Consultar
549013	Cable 1 x 2,5	100	100	Consultar
549022	Cable 2 x 1,5	100	100	Consultar
549024	Cable 2 x 2,5	100	100	Consultar
549030	Cable 3 x 1,5	100	100	Consultar
549032	Cable 3 x 2,5	100	100	Consultar



Pilas alcalinas

Código	Artículo			€/Ud.
620602	Pila alcalina AAA	40	4	0,90
620604	Pila alcalina LR6 1,5 V	40	4	0,73
620612	Pila alcalina 6LR61 9 V	50	1	2,89



Conexiones aspersores y difusores

Código	Artículo			€/Ud.
281010	Codo articulado 1" BSP	1	1	32,92
281012	Codo articulado 1 1/2" BSP	1	1	95,00
281116	Codo articulado 15cm 1/2x1/2	25	25	4,18
281125	Codo articulado 15cm 3/4x3/4	25	25	4,62
281016	Codo articulado 30 cm rosca 1/2"x1/2"	25	25	5,17
281025	Codo articulado 30 cm rosca 3/4"x3/4"	25	25	5,44
298391	Conexión dif. Codo mixto 1/2" 13x17	1000	100	0,34
298193	Conexión dif. Codo mixto 3/4" 13 x 17	1000	100	0,34
298301	Conexión dif. recta mixto 1/2" 13 x 17	1000	100	0,19
298103	Conexión dif. recta mixto 3/4" 13 x 17	1000	100	0,19
536901	Tubo flexible 13 x 17 en rollo 30 mts.	3360	30	0,88
51007	Alargador bobina 1/2"	700	50	0,41
51014	Alargador bobina 1/2" x 3/4"	600	50	0,41
51026	Alargador bobina 3/4"	500	25	0,42



Colectores para electroválvulas

Colector modular

Código	Artículo			€/Ud.
790010	Te Colector valvula 1"	156	12	2,31



Colectores Polipropileno

Código	Artículo			€/Ud.
310032	Cruz rosca loca 1"	100	50	6,77
791032	Te rosca loca 1"	100	50	4,53
286032	Codo 90° rosca loca 1"	150	50	2,10
870032	Unión recta rosca loca 1"	150	50	2,67
602032	Nipple 1" con junta	300	50	1,27



Colectores PVC. Serie profesional

Código	Artículo			€/Ud.
310132	Cruz rosca loca 1". S. Prof.	80	10	5,96
310150	Cruz rosca loca 1 1/2". S. Prof.	20	5	15,24
791132	Te rosca loca 1". S. Prof.	160	20	4,11
791150	Te rosca loca 1 1/2". S. Prof.	40	5	13,50
286132	Codo rosca loca 1". S. Prof.	120	20	3,50
286150	Codo rosca loca 1 1/2". S. Prof.	60	15	11,47
781132	Tapón 1" S. Prof.	100	1	1,35
602132	Nipple 1". S. Prof.	400	20	1,54
602148	Nipple 1 1/2" x 1". S. Prof.	300	120	5,47
602150	Nipple 1 1/2". S. Prof.	300	120	5,47
292102	Colector 2 salidas	70	1	8,30
292103	Colector 3 salidas	50	1	12,30
292104	Colector 4 salidas	40	1	16,30



Arquetas

Arquetas Irritrol Hércules

Irritrol

Código	Artículo			€/Ud.
302067	Arqueta Hercules 070	375	375	4,58
302037	Arqueta Hércules 1100	276	276	8,00
302042	Arqueta Hércules 1419	162	162	25,74
302052	Arqueta Hércules 1220	104	104	45,53



Arquetas Ris con tirador

Código	Artículo			€/Ud.
301967	Arqueta circular Ø 25 cm. Mod. R 070	792	1	5,06
301937	Arqueta circular Ø 34 cm. Mod R 1100	396	1	8,65
301942	Arqueta rectan. 40 x 53 cm. Mod. R 1419	144	1	26,73
301952	Arqueta rectan. 50 x 66 cm. Mod. R 1220	96	1	42,47
301990	Arqueta rectan. 59 x 81 cm. Mod. SuperYumbo	24	1	137,45
771367	Tapa arqueta R 070 Ø16 cm	1	1	3,46
771337	Tapa arqueta R 1100 Ø26 cm	1	1	5,92
771342	Tapa arqueta R 1419 28 x 40 cm	1	1	17,88
771352	Tapa arqueta R 1220 39 x 56 cm	1	1	25,61



Arquetas sencillas

Código	Artículo			€/Ud.
301800	Arqueta cuadrada peq.074	500	1	7,99
301850	Arqueta cuadrada peq.1419P	250	1	16,87



Arquetas sencillas para aguas residuales

Código	Artículo			€/Ud.
303800	Arqueta cuad.pe 074 morada	500	1	12,04
303850	Arqueta cuad.pe1419P morada	250	1	20,37



Hidrantes y pinchos metálicos

Código	Artículo			€/Ud.
479225	Hidrante 3/4" latón Tapa plástico	40	1	20,64
479228	Hidrante 3/4" latón T. Plást con cierre	40	1	23,26
479232	Hidrante 1" latón Tapa Plástico	25	1	37,69
501200	Llave apertura Hidrante	10	10	5,56
504816	Llave 3/4" Salida 3/4 M -1/2 H	40	40	12,35
504825	Llave 1" Salida 1" M -3/4 H	25	25	16,01
285082	Codo loco latón 3/4 x 3/4"	40	40	13,42
285083	Codo loco latón 1" x 1"	40	25	18,24
634070	Pincho porta-aspersor 1/2" latón	25	25	19,62
634075	Pincho porta-aspersor 1/2" zinc	200	50	5,35



Hidrantes de plástico

Código	Artículo			€/Ud.
892025	Hidrante 3/4" plastico	50	50	6,97
505025	Llave de bayoneta 3/4" plastico	100	100	3,21



Bocas de riego

Código	Artículo			€/Ud.
152525	Boca de riego 3/4" x 3/4"	288	6	25,25
152532	Boca de riego 3/4" x 1"	12	6	50,87



Cintas y sellantes

Cinta Teflón

Código	Artículo			€/Ud.
506512	Teflon 12 m x 12 mm	250	25	0,50
506519	Teflon 50 m x 19 mm	25	25	3,49





Hilo sellador

Código	Artículo			€/Ud.
479556	Hilo sellador L 55 (Bote 160 m)	48	1	31,09





Gel sellador

Código	Artículo			€/Ud.
440853	Gel sellador L 5331 (Bote 100 ml)	12	1	50,87





Líquido sellador

Código	Artículo			€/Ud.
734054	Sellador líquido L 542 (Bote 50 ml)	12	1	83,33





Grifos

Código	Artículo			€/Ud.
470012	Grifo 1/2" para manguera	36	16	8,08
470034	Grifo 3/4" para manguera	32	10	9,84
470036	Grifo 1" para manguera	24	6	10,67



Derivación dos salidas

Código	Artículo			€/Ud.
349100	Derivación dos salidas latón 3/4" H-M-M	40	10	21,86



Mangueras y complementos

Manguera Iboplus

Código	Artículo			€/Ud.
543582	Manguera Iboplus 5/8"(15mm) R 25	25	25	2,09
543585	Manguera Iboplus 5/8"(15mm) R 50	50	50	2,42
543343	Manguera Iboplus 3/4"(19mm) R 25	25	25	3,69
543345	Manguera Iboplus 3/4"(19mm) R 50	50	50	3,42



Manguera extensible

Código	Artículo			€/Ud.
537515	Manguera extensible	20	20	7,50



Accesorios de plástico para mangueras

Código	Artículo			€/Ud.
294832	Conector para grifo H 1" y 3/4"	200	200	1,02
294831	Conector para grifo H 3/4 y 1/2	200	250	0,91
294834	Conector 3/4" macho	200	100	0,37
505500	Manguito conector	1600	400	0,41
294912	Conector a tubo 1/2"	180	150	1,43
294934	Conector a tubo 3/4"	120	100	1,87
391012	Empalme reparación manguera 1/2"	180	150	0,74
391034	Empalme reparación manguera 3/4"	120	100	1,18
506506	Lanza regulable	200	50	1,95
506507	Pistola multifunción. 7 F	40	20	7,82



Accesorios de latón para mangueras

Código	Artículo			€/Ud.
505503	Manguito conector latón	500	50	2,08
294938	Conector a tubo 3/4 stop latón	100	10	5,41
391036	Empalme reparación 3/4 latón	100	10	3,76
506509	Lanza regulable latón	100	10	4,31





Nebulización media y baja presión

Código	Artículo			€/Ud.		Código	Artículo			€/Ud.	
500005	Kit Nebulización Drip & Fresh	10	1	79,67		784415	Te Automática 3/8" para Tobera	100	100	3,96	
416403	Extensión Kit nebulización	10	1	46,09		780018	Tapón final 3/8" para tobera	50	50	3,09	
500001	Kit Nebulización mini	10	10	12,77		780012	Tapón Automático 3/8"	50	50	2,04	
647030	Air Cooler	0	100	4,05		536710	Tubería blanca 3/8". Rollo 25 mts.	25	25	2,01	
500006	Kit portatil drip&fresh (4T)	20	1	56,95		780016	Tapón de latón	25	25	1,65	
494600	Kit Ultravioleta 6W 2 l/min	1	1	225,51		100103	Tobera de Latón 0,3 mm.	100	100	1,98	
494610	Kit Ultravioleta 16 li/min	1	1	526,75		784417	Te con tobera y antigoteo violeta 1,5 bar	1	1	9,23	
900100	Vaso portafiltro 5"	3	1	47,74		784418	Te con tobera y antigoteo Naranja 4 bar	1	1	12,02	
438000	Filtro de sales de Polifostato	1	1	21,40		650012	Prog. Grifo Nebulización digital	1	1	50,87	
438011	Filtro de hilo de polipropileno 1 micra	1	1	4,94		650000	Programador + electroválvula	5	1	182,88	
295012	Conexión automática macho 3/8" M	50	50	4,03		879514	Electroválvula latón 3/8" 14 Bar 24VAC	1	1	160,32	
38025	Adaptador de grifo 3/4"H Automático	10	10	4,40		161170	Bomba Shrufllo By-pass y manómetro.	1	1	440,74	
38016	Adaptador de grifo 3/8"H Automático	10	10	7,58		161176	Bomba Shrufllo sin equipar	1	1	303,70	
289012	Codo Automático 3/8"	50	50	3,79							
784412	Te Automática 3/8"	50	50	4,28							
870012	Unión Automática 3/8"	50	50	3,95							



Nebulización alta presión

Bombas Nebulización AP

Bomba AP NOVA

Código	Artículo			€/Ud.
473015	Bomba AP NOVA I 1,5 lpm	1	1	1.396,54



Bomba AP LG

Código	Artículo			€/Ud.
406002	Bomba AP LG 2 lpm	1	1	2.493,83
406004	Bomba AP LG 4 lpm	1	1	2.560,33
406006	Bomba AP LG 6 lpm	1	1	2.693,33
406008	Bomba AP LG 8 lpm	1	1	2.726,58
406020	Bomba AP LG 20 lpm	1	1	3.825,15



Accesorios nebulización alta presión

Código	Artículo			€/Ud.
879680	Electroválvula latón 3/8" 80 Bar 220VAC	1	1	69,83



157005	Tobera Fog 0,2. Alta presión	100	1	8,64
157015	Tobera Fog 0,15. Alta presión	100	1	8,64



529401	Tubo negro Poliamida HP 5x10 mm R 10 mts	10	10	8,55
529400	Tubo negro Poliamida HP 5x10 mm	100	100	8,19
529411	Tubo blanco Poliamida HP 5x10 mm R 10 mts	10	10	8,55
529410	Tubo blanco Poliamida HP 5x10 mm	100	100	8,19



700014	Racor recto 1/4"M Nebulizacion	25	25	4,99
--------	--------------------------------	----	----	------



700007	Racor recto HP 3/8"	10	10	9,00
--------	---------------------	----	----	------



280006	Codo intermedio 3/8 nebulización	10	10	9,43
--------	----------------------------------	----	----	------



794010	Te intermedia 3/8 nebulización	10	10	14,34
--------	--------------------------------	----	----	-------

310006	Racor cruz HP 3/8"	10	10	23,41
--------	--------------------	----	----	-------



780014	Tapón HP 3/8"	25	25	2,76
--------	---------------	----	----	------



700008	Recto intermedio para boquilla	25	25	10,89
--------	--------------------------------	----	----	-------

280008	Codo HP para tobera 3/8"	10	10	8,36
--------	--------------------------	----	----	------

892011	Válvula tubo HP 3/8"	6	6	19,29
--------	----------------------	---	---	-------





Césped artificial

RIS Bicapa

Código	Artículo	Ancho x Largo	m ²	€/Ud.
506414	Ris Bicapa 14 mm	2 x 25	50	17,28



Bermeo Bicapa

Código	Artículo	Ancho x Largo	m ²	€/Ud.
506353	Bermeo Bicapa 30 mm	2 x 15	30	21,71
506374	Bermeo Bicapa 40 mm	2 x 15	30	26,61



Accesorios césped artificial

Código	Artículo			€/Ud.
90485	Adhesivo PU Bicomponente	12	12	9,7 €/Kg
90484	Adhesivo PU Bicomponente	5	5	10,5 €/Kg
506599	Geotextil 30 cm	100	100	1,93 €/m
90007	Arena Sílicea Saco 25 Kg	1	1	11,11 €/saco



506525	Cinta unión autoadhesiva 15 cm x 5 mts.	15 cm x 5m	5	7,8 €/Mt.
506528	Cinta unión autoadhesiva 15 cm x 10 mts.	15 cm x 10m	10	7,45 €/Mt.



506520	Cinta fijación 2 caras 5 cm x 10 mts.	5 cm x 10m	10	2,3 €/Mt.
--------	---------------------------------------	------------	----	-----------



CONDICIONES GENERALES DE VENTA

PEDIDOS

Todos los pedidos han de realizarse por escrito y firmados por personas debidamente acreditadas. Los pedidos podrán anticiparse por teléfono, debiendo ratificarse por escrito. Los pedidos aceptados estarán sujetos a los términos y condiciones de venta de **Ris Iberia, S.L.**

Importante: Todos los pedidos que no se adapten a las unidades de embalaje de nuestra tarifa llevarán un recargo del 10% en concepto de acondicionamiento.

PORTES

Los portes son por cuenta del comprador, así como cualquier gasto no previsto (embalaje, envíos marítimos y aéreos). La mercancía viaja siempre por cuenta y riesgo del comprador.

FORMAS DE PAGO

Al contado: Se entenderá por contado aquellas operaciones que al tiempo de recibir el pedido por escrito hayan enviado el importe a Ris Iberia, S.L.

Pago aplazado: Para distribuidores autorizados que hayan satisfecho los requerimientos comerciales de la sociedad, el pago se realizará como máximo a 60 días fecha factura.

El primer pedido (clientes nuevos) será siempre al contado.

Los pedidos serán aceptados y facturados a los precios en vigor a la fecha de su expedición.

Los precios están sujetos a modificación sin notificación previa.

Los precios de nuestra tarifa en vigor se entienden sin inclusión de impuestos.

GARANTÍA

Ris Iberia, S.L. garantiza los materiales que suministra contra todo defecto de fabricación, por período de un año a partir de la fecha de compra, cubriendo la reposición de los materiales defectuosos una vez que sean comprobados por nuestro personal, siendo por cuenta del cliente la mano de obra empleada en el montaje o reparación.

Ris Iberia, S.L. no se responsabiliza de los posibles daños o perjuicios que puedan ocasionarse a usuarios o terceros.

Los materiales para reparar se reciben libres de gastos de envío y se devolverán a portes debidos.

DEVOLUCIONES Y RECLAMACIONES

No se admiten reclamaciones a partir de los 3 días de la entrega de la mercancía.

No se admiten devoluciones transcurridos 15 días desde la entrega del material.

Esta tarifa anula todas las anteriores.

COMPROMISO DE CALIDAD

SISTEMA DE CALIDAD CONFORME A LA NORMA ISO 9001:2015

RIS Iberia S.L. cuenta con certificación en el sistema de Gestión de Calidad conforme a la Norma ISO 9001:2015, este sello refleja nuestro compromiso innegociable con la excelencia en todos los aspectos de nuestro servicio. El reconocimiento, otorgado por AENOR (Asociación Española de Normalización y Certificación), subraya nuestra dedicación a proporcionar productos y servicios de la más alta calidad, alineándonos con los estándares internacionales reconocidos.

En RIS Iberia S.L., entendemos que la calidad no es solo un estándar que cumplir, sino una filosofía arraigada en nuestra cultura empresarial. La certificación ISO 9001:2015 valida nuestra capacidad para superar las expectativas de nuestros clientes y garantiza que cada interacción con nosotros esté respaldada por un sistema de gestión de calidad sólido y eficiente.

Al adoptar los principios fundamentales de la norma ISO 9001:2015, como el enfoque al cliente, la mejora continua y la participación del personal, garantizamos que cada aspecto de nuestra operación esté alineado con las necesidades y expectativas de quienes confían en nosotros.

La certificación no solo nos posiciona como líderes en calidad, sino que también nos convierte en un socio comercial confiable. Nuestros clientes pueden confiar en que cada producto y servicio que ofrecemos cumple con los estándares más rigurosos.

Al elegir RIS Iberia S.L., nuestros clientes no solo eligen productos y servicios de alta calidad, sino también la tranquilidad de saber que están asociados con una empresa comprometida con la excelencia en cada paso.



ER-0461/2021 ZARAGOZA



LISTADO DE MODIFICACIONES EN ESTE DOCUMENTO FRENTE A TARIFA IMPRESA 2024

- Página 7: Añadidos artículos 750310, 582548 y 659002
- Página 8: Cambiados códigos Neptune ø22
- Página 9: Código duplicado 539705 eliminado, añadimos 539641
- Página 32: Nuevo texto incluye tipo de fitting, solenoide y piloto, además de especificar transporte.
- Página 47: Añadido Solenoide Geva 75 3 vías 12vdc NO - Código 719949
- Página 47: Añadido conector estanco cables para Gem Sol código 294950
- Página 47: Añadido repuesto petaca solenoide larga distancia código 294955
- Página 48: Añadidos kits para válvulas con solenoides Baccara
- Página 50: Añadida Te orientable mixta 6*6*1/4" código 794544
- Página 55: Añadida Bomba MX 075 - Código 382075
- Página 69: Añadidos más sensores sistema Tempus
- Página 71: Eliminado programador MCE

ACTUALIZACIONES DE PRECIOS (marcados con línea verde junto a su tabla en cada página)

- Precios modificados en páginas 4,5,6 y 7

- Página 14:

Código	Artículo			€/Ud.
512253	25 mts. Pe 16, 2 l. integr. 0,33	180	25	0,4087
512283	50 mts. Pe 16, 2 l. integr. 0,33	90	50	0,4350
512303	100 mts. Pe 16, 2 l. integr. 0,33	48	100	0,3811
512255	25 mts. Pe 16, 2 l. integr. 0,50	180	25	0,3757
512285	50 mts. Pe 16, 2 l. integr. 0,50	90	50	0,4101
512305	100 mts. Pe 16, 2 l. integr. 0,50	48	100	0,3563

Código	Artículo			€/Ud.
517025	25 mts. Ris Pe 16, 2 l. 0,33 marrón	180	25	0,5122
517100	100 mts. Ris Pe 16, 2 l. 0,33 marrón	48	100	0,4162
517400	400 mts. Ris Pe 16, 2 l. 0,33 marrón	12	350	0,3751
518025	25 mts. Ris Pe 16, 2 l. 0,50 marrón	180	25	0,4554
518100	100 mts. Ris Pe 16, 2 l. 0,50 marrón	48	100	0,3914
518400	400 mts. Ris Pe 16, 2 l. 0,50 marrón	12	400	0,3182

- Página 15:

Código	Artículo			€/Ud.
529132	Ris PC 16 a 33 cm, 2 lt. Morado 2,2 lph	12	350	0,7447
529152	Ris PC 16 a 50 cm, 2 lt. Morado 2,2 lph	12	400	0,5886

Código	Artículo			€/Ud.
513732	Ris PC 16, 100 mts, sep. 33 cms 2,2 lph	48	100	0,7407
513752	Ris PC 16, 100 mts, sep. 50 cms 2,2 lph	48	100	0,5886

- Página 17:

Código	Artículo	€/Ud.
529033	Ris PC 16, marrón, 400 mts, sep. 33 cms 2,2 lph	12 350 0,7447
515751	Ris PC 16, marrón, 50 mts, sep. 50 cms 2,2 lph	72 50 0,6845
515752	Ris PC 16, marrón, 100 mts, sep. 50 cms 2,2 lph	48 100 0,6110
529050	Ris PC 16, marrón, 400 mts, sep. 50 cms 2,2 lph	12 400 0,5886

- Página 47:

Código	Artículo			€/Ud.
714885	Geva 75 2 vías latch 9-12V DC	50	50	23,19
714712	Geva 75 2 vías 12 VDC	50	50	20,09

719937	Geva 75 3 vías 1,6 mm 24V AC N/C	25	25	36,71
719926	Geva 75 3 vías 1,6 mm 24V AC N/O	25	25	36,71
719949	Geva 75 3 vías 1,6 mm 12VDC N/O	25	25	36,71
719940	Geva 75 3 vías 1,6 mm latch 9-12V DC N/C	25	25	41,15
719941	Geva 75 3 vías 1,6 mm latch 9-12V DC N/O	25	25	41,15



719904	Solen G 75 A3P 3W 1/8 latch 2,6 mm	10	10	52,90
--------	------------------------------------	----	----	-------



719970	Solen G 75 3 vías latch colector R	10	10	63,62
719977	Solen G 75 3 vías latch colector M	10	10	63,62
719974	Solen G 75 3 vías latch colector L	10	10	63,62
764071	Soporte colector Solen G 75	10	10	15,52

Código	Artículo			€/Ud.
717316	Gemsol 3 vías 1,6 mm 24V AC N/C	30	30	60,24
717317	Gemsol 3 vías 1,6 mm 24V AC N/O	30	30	60,24
716316	Gemsol 3 vías 1,6 mm 12V DC N/C	30	30	60,24
716317	Gemsol 3 vías 1,6 mm 12V DC N/O	30	30	60,24
717341	Gemsol 3 vías 2 mm latch 9-12 V N/C	30	30	70,27
717340	Gemsol 3 vías 2 mm latch 9-12 V N/O	30	30	70,27
716111	Gemsol 3 vías 1,6 mm 110V AC N/C	30	30	60,24
716110	Gemsol 3 vías 1,6 mm 110V AC N/O	30	30	60,24



719812	Solen. 3 W 1/8" Larga Distancia 12 VDC 1,6mm	20	1	199,53
719824	Solen. 3 W 1/8" Larga Distancia 24 VAC 1,6mm	20	1	199,53
719810	Solen. 3 W 1/8" Larga Distancia 12/24 VAC	50	1	128,27

- Página 53:

Código	Artículo			€/Ud.
328020	Cont. chorro múltiple RWS DN 20 mm 3/4"	10	1	95,00
328025	Cont. chorro múltiple RWS DN 25 mm. 1"	3	1	113,36
328030	Cont. chorro múltiple RWS DN 30 mm. 1 1/4"	5	1	129,55
328040	Cont. chorro múltiple RWS DN 40 mm. 1 1/2"	4	1	221,31
328050	Cont. chorro múltiple RWS DN 50 mm. 2"	1	1	248,30
408018	Emisor de impulsos RWS	1	1	44,53

Código	Artículo			€/Ud.
327050	Contador RTWI DN 50 mm 2"	1	1	293,72
327065	Contador RTWI DN 65 mm 2 1/2"	1	1	332,51
327080	Contador RTWI DN 80 mm 3"	1	1	399,01
327100	Contador RTWI DN 100 mm 4"	1	1	432,26
327125	Contador RTWI DN 125 mm 5"	1	1	576,35
327150	Contador RTWI DN 150 mm 6"	1	1	653,94
327200	Contador RTWI DN 200mm 8"	1	1	886,69



- Página 56:

Código	Artículo			€/Ud.
893901	Válvula 1/2" 24 VAC para abonado	20	10	135,77

- Página 66:

Código	Artículo	€/Ud.
649510	Presostato diferencial digital	231,22

- Página 70:

Código	Artículo			€/Ud.
669809	Programador G75 con solen 9 V	1	1	98,04
665075	Programador G75 1 Stn sin solen	1	1	86,73
669812	Programador G75 2 Stn	1	1	116,93
669814	Programador G75 4 Stn	1	1	147,27

- Página 81:

Código	Artículo			€/Ud.
310132	Cruz rosca loca 1". S. Prof.	80	10	5,96
310150	Cruz rosca loca 1 1/2". S. Prof.	20	5	15,24
791132	Te rosca loca 1". S. Prof.	160	20	4,11
791150	Te rosca loca 1 1/2". S. Prof.	40	5	13,50
286132	Codo rosca loca 1". S. Prof.	120	20	3,50
286150	Codo rosca loca 1 1/2". S. Prof.	60	15	11,47
781132	Tapón 1" S. Prof.	100	1	1,35
602132	Nipple 1". S. Prof.	400	20	1,54
602148	Nipple 1 1/2" x 1". S. Prof.	300	120	5,47
602150	Nipple 1 1/2". S. Prof.	300	120	5,47
292102	Colector 2 salidas	70	1	8,30
292103	Colector 3 salidas	50	1	12,30
292104	Colector 4 salidas	40	1	16,30

Código	Artículo			€/Ud.
325050	Contador Woltman RWN DN 50 mm 2"	1	1	321,98
325065	Contador Woltman RWN DN 65 mm 2 1/2"	1	1	353,90
325080	Contador Woltman RWN DN 80 mm 3"	1	1	430,88
325100	Contador Woltman RWN DN 100 mm 4"	1	1	463,02
325125	Contador Woltman RWN DN 125 mm 5"	1	1	554,18
325150	Contador Woltman RWN DN 150 mm 6"	1	1	771,15
325200	Contador Woltman RWN DN 200mm 8"	1	1	920,78
325250	Contador Woltman RWN DN 250mm 10 "	1	1	1.646,48
325300	Contador Woltman RWN DN 300mm 12"	1	1	3.186,56
323400	Contador Woltman RWN DN 400mm 16"	1	1	10.529,49
323500	Contador Woltman RWN DN 500mm 20"	1	1	14.187,11
408010	Emisor de impulsos RTW y RWN	1	1	45,72

- Página 61:

Código	Artículo	€/Ud.
200932	Cartucho malla 3/4" y 1"	3,29
200950	Cartucho malla 1 1/4" y 1 1/2"	11,53
200963	Cartucho malla 2"	12,36
200990	Cartucho malla 3"	28,83
200732	Cartucho discos 3/4" y 1"	4,53
200750	Cartucho discos 1 1/4" y 1 1/2"	14,83
200763	Cartucho discos 2"	20,59
200790	Cartucho discos 3"	37,07

- Página 82:

Código	Artículo			€/Ud.
301967	Arqueta circular Ø 25 cm. Mod. R 070	792	1	5,06
301937	Arqueta circular Ø 34 cm. Mod R 1100	396	1	8,65
301942	Arqueta rectan. 40 x 53 cm. Mod. R 1419	144	1	26,73
301952	Arqueta rectan. 50 x 66 cm. Mod. R 1220	96	1	42,47
301990	Arqueta rectan. 59 x 81 cm. Mod. SuperYumbo	24	1	137,45
771367	Tapa arqueta R 070 Ø16 cm	1	1	3,46
771337	Tapa arqueta R 1100 Ø26 cm	1	1	5,92
771342	Tapa arqueta R 1419 28 x 40 cm	1	1	17,88
771352	Tapa arqueta R 1220 39 x 56 cm	1	1	25,61



Zaragoza

C/ Los Ángeles, 9
Polígono Centrovía
50198, La Muela
976 144 700

Sevilla

C/ San Nicolás Diez, 33B
Polígono San Nicolás
41500 Alcalá de Guadaíra
955 996 784

Madrid

C/ Tales de Mileto, 15, N.29
Polígono Mapfre
28806 Alcalá de Henares
918 020 292

Barcelona

683 312 296
629 766 285
noemi.bonilla@risiberia.es

La Coruña

C/ Juan Diaz Porlier, 19,
Esc. Derecha, 7°C,
15009 A Coruña
981 244 142

Valencia

669 421 585
armando.orts@risiberia.es